



A.B.C. MORINI

CLASSIC



**ACCESSORI PER
BORSE, CINTURE, CALZATURE E CONFEZIONI**

**ACCESSORIES FOR
HANDBAGS, BELTS, SHOES AND CLOTHINGS**

A.B.C. MORINI

CLASSIC



**ACCESSORI PER
BORSE, CINTURE, CALZATURE E CONFEZIONI**

***ACCESSORIES FOR
HANDBAGS, BELTS, SHOES AND CLOTHINGS***

CATEGORE MERCEOLOGICHE	GOODS CATEGORIES	CAT/PAG
ANELLI	RINGS	1/1 - 1/21
ATTACCHI	HANDLE HOLDERS	2/1 - 2/13
BORCHIE	BASE STUDS	3/1
BOTTONI AUTOMATICI	SNAPS	22/1 - 22/2
CALAMITE/MAGNETI	MAGNETS	5/1 - 5/3
CATENE	CHAINS	4/1 - 4/5
CERNIERE	FRAMES	7/1
CHIUSURE	LOCKS	6/1 - 6/18
ESEMPI DI PERSONALIZZAZIONE	EXAMPLES OF CUSTOMIZATION	23/1
FASCETTE-TERMINALI	CLAMPS-TIPS	19/1
FIBBIE	BUCKLES	8/1 - 8/36
GEMELLI-VITI	STUDS-SCREWS	9/1 - 9/2
GUARNIZIONI	ORNAMENTS	10/1 - 10/5
MOSCHETTONI	DOG CLIPS	12/1 - 12/16
OCCHIELLI	EYELETS	13/1 - 13/5
PASSANTI	KEEPERS	15/1
PORTACHIAVI-ANELLI BRISE'	KEY HOLDER-SPRING RINGS	16/1 - 16/4
RIVETTI	RIVETS	17/1 - 17/2
SCORREVOLI	SLIDING BARS	18/1 - 18/4
FASCETTE	CLAMPS	19/1
TIRALAMPO	ZIP PULLERS	20/1 - 20/7
UTENSILI	TOOLS	21/1 - 21/8





F/94/1



F/114/1



F/92/1



F/112/1



F/90/1



F/70/1



F/68/1



F/64/1



F/52/1



F/60/1



F/48/1



F/44/1



F/40/1



F/26/1



F/38/1



F/10/1



F/22/1



F/20/1

PER MATERIALI E MISURE VEDI INDICE - FOR MATERIALS AND SIZES PLS. SEE INDEX



F/118/1



F/126/1



F/128/1



F/142/4



F/140/4



F/130/1



F/131/1



F/124/1



F/120/1



F/283/1



F/260/1



F/246/1



F/254/1



F/278/1



F/244/1



F/236/1



F/242/1



F/210/1



F/214/1



F/216/1



F/228/1



F/234/1



F/314/1



F/312/1



F/294/1



F/317/1



F/319/1



F/303/1



F/288/1



F/274/1



F/264/1



F/261/1



F/390/1



F/386/1



F/388/1



F/370/1



F/382/1



F/396/1



F/398/1



F/372/1



F/368/1



F/352/1



F/424/1



F/422/1



F/414/1



F/406/1



F/412/1



F/378/1



F/397/1



F/404/1



F/430/1



F/428/1



F/418/1



F/600/1



F/590/1



F/511/1



F/510/1



F/502/1



F/498/1



F/492/1



F/474/1



F/468/1



F/545/1



F/548/1



F/549/1



F/523/1



F/522/1



F/519/1



F/521/1



F/518/1



F/516/1



F/515/1



F/512/1



F/578/1



F/576/1



F/573/1



F/572/1



F/566/1

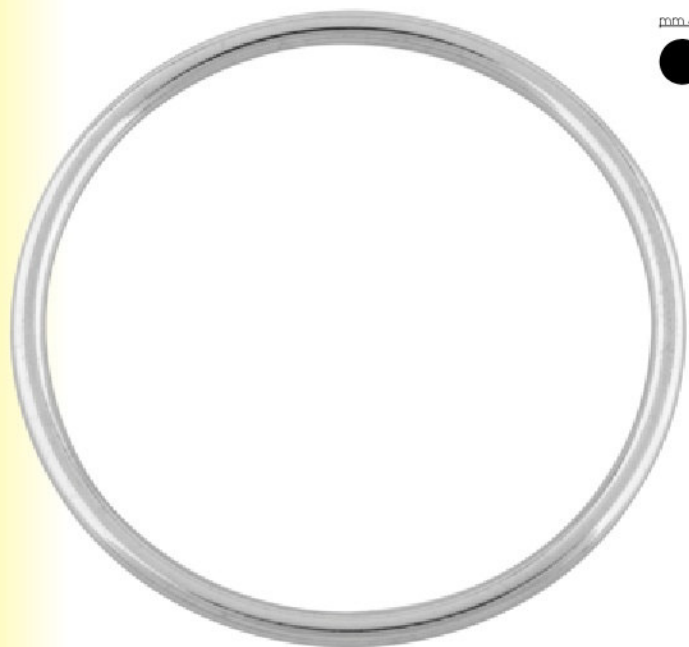

mm 47



C/5958/80



mm 63



C/4636/55



mm 62



C/4636/50



mm 63



C/4636/40



mm 60



C/4636/35



mm 50



C/3119/25



mm 60



D/873/32



mm 55



C/4636/30

DISPONIBILE IN mm 30
ALSO AVAILABLE IN mm 30

mm 3,2



C/6141/14

mm 5,0



C/6700/20

mm 4,0



C/4589/20

mm 3,8



C/4588/25

mm 4,5



C/5945/25

mm 5,0



C/5941/60

DISPONIBILE IN mm 40
ALSO AVAILABLE IN mm 40

mm 6,0
mm 5,7

ANELLI - RINGS
1-12



D/468/20



D/468/26



C/5928/35



C/5723/37

DISPONIBILE IN mm 28 - 40
ALSO AVAILABLE IN mm 28 - 40



C/5113/15

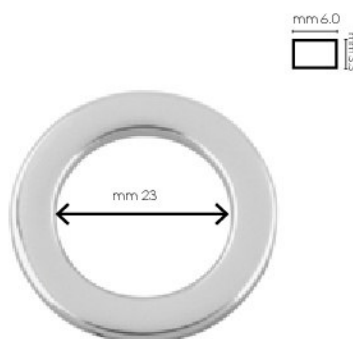

D/727

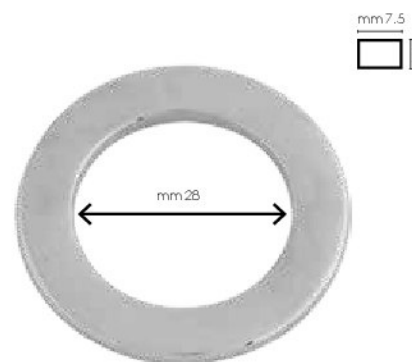

D/1198



D/240/35

DISPONIBILE IN mm 30
ALSO AVAILABLE IN mm 30



C/6046/20



C/6046/25



C/6046/30



C/6046/35



C/6046/40



C/6046/50



C/4617/30



C/4617/25



D/881/20



C/6109/15



C/5936/40



D/1348/40



C/6158/15



C/6158/20



C/6158/25



C/6196/25



C/6161/38



C/5946/20

DISPONIBILE IN mm 15 - 25
ALSO AVAILABLE IN mm 15 - 25



C/5947/30

DISPONIBILE IN mm 20 - 25
ALSO AVAILABLE IN mm 20 - 25



C/4245/20



C/4244/25



C/6075/30

mm 5.5



C/6075/40

mm 5.9



C/6090/40

mm 7.0



C/6178/40

mm 7.9



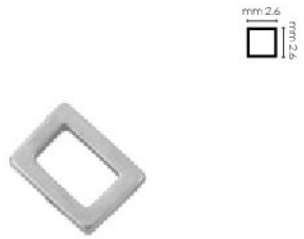

C/5573/10

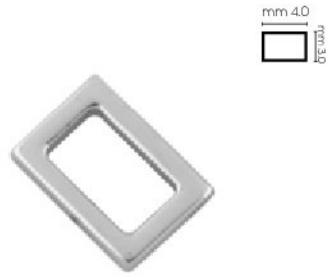

C/5513/16

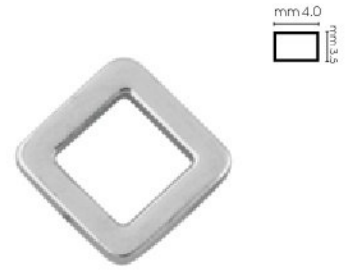

C/5720/15

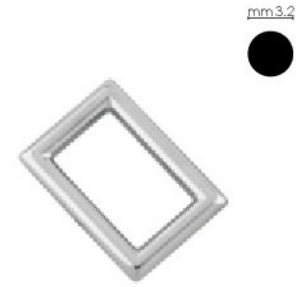

C/4467/16



C/5517/20

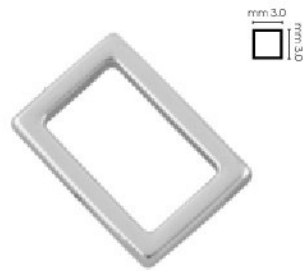

C/5773/20



C/5781/30



C/5457/20



C/5457/25



C/5457/30



C/5457/35



D/721/20



D/721/25



D/721/30



D/721/40



D/1154/10



D/1154/15



D/1154/20



D/1154/25



C/4416/15



C/5636/15



C/4243/20



C/4243/25



C/6064/8



C/6750/10



C/5876/14



C/6032/15



C/5672/15



C/5676/16



C/6040/20



C/6040/25



C/6040/30



C/6040/40



C/6108/20



C/6108/25



C/6069/40



C/5520/30

DISPONIBILE IN mm 15 - 20 - 25
ALSO AVAILABLE IN mm 15 - 20 - 25



C/5434/30

DISPONIBILE IN mm 20 - 25 - 35 - 40
ALSO AVAILABLE IN mm 20 - 25 - 35 - 40



C/5614/20

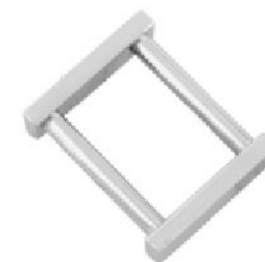

D/405/20

DISPONIBILE IN mm 25
ALSO AVAILABLE IN mm 25



A/6161/20



D/560/20

DISPONIBILE IN mm 24
ALSO AVAILABLE IN mm 24



D/1435/15



D/195/20



D/1266/20



C/6320/30



C/6320/40



A/5811/20



C/6061/20



C/6061/25



A/4486/25



A/4486/20



A/4999/20



D/211/20



D/211/25



D/1112/20



D/1112/25



D/808/20



D/637/25



D/164/15



D/164/20



D/1391/20



D/1380/10



D/1254/5



D/1278/15 *



D/1278/20 *



D/1278/25 *

* PER FIBBIA VEDI D/1268
AS BUCKLE ITEM D/1268



D/326/...

ESEMPIO - EXAMPLE



D/326/...

ESEMPIO - EXAMPLE

VISTA FRONTALE - FRONTAL VIEW



D/326/37



D/326/31



D/326/25



D/1185



D/671



D/489/20



D/489/25



D/489/30



D/1273



D/717



D/1253



D/1250



C/4775



C/5029/8



D/1403/18



D/1359



D/1379/20



D/1353/20





D/1252/20



C/4257

DESTRO E SINISTRO
LEFT AND RIGHT



D/193

DESTRO E SINISTRO
LEFT AND RIGHT



D/1460/20



D/1474/20



D/1476



D/878/20



D/795

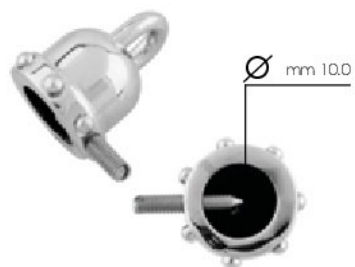

D/714

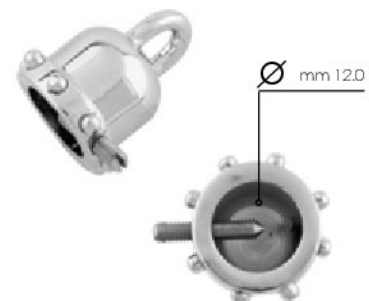

D/716



C/4767



D/756/1



C/5200



D/1003

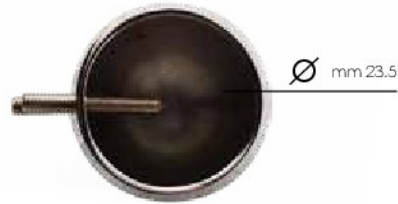

D/1406



D/1444/5



A/6747

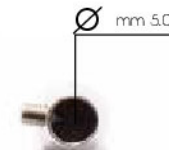



D/1220/20



D/1259/20



C/5724/9



C/5724/12



C/5724/14



C/5724/...



A/3698/7



A/3698/9



A/3698/12



A/3698/14



A/3698/18



A/3698/22



A/3698/...



A/3697/5



A/3697/7



A/3697/9



A/3697/12



A/3697/14



A/3697/16



A/3697/18



A/3697/20



A/3697/22



A/3697/24



A/3697/...



X/1/60/0033
G300



X/1/60/0034
G 300 L



X/1/60/0040
G 300 AL



X/1/60/0026
G 250



X/1/60/0027
G 250 L



X/1/60/0065
G 250 DOPPIA

X/1/60/0019
G 200 L



X/1/60/0018
G 200



X/1/60/0012
G 150 L





D/1416/100



C/5842/100



C/5872/100



E/3779/100



A/6652/100

C/6720/100



C/6059/100



C/6060/100



C/6155/100





C/6163/100



C/6164/100



C/6165/100



D/1282/100



A/7376



A/7375



C/2853



D/141



D/666

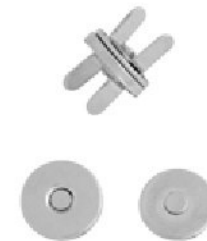

D/1300



C/6756



C/6757



C/3400

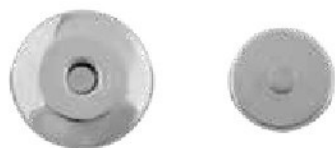

K/958

CON RIVETTO - WITH RIVET

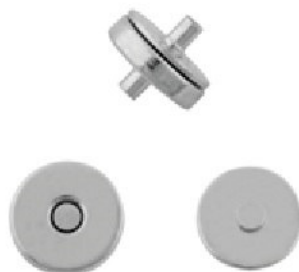

C/1433



A/8999



C/6305/6
mm 6x2



C/6305/10
mm 10x2



C/5610/18
mm 18x3



C/5617/20
mm 20x3



C/5609/20
mm 20x2



C/5688/30
mm 30x3



C/5662/20
mm 20x10x2





A/3526



A/3528



K/1116



A/3518/1



K/461



D/870



D/765



D/444



D/872



D/259



D/1373



D/804



D/900



C/5224



D/361



D/364





D/1304



D/1322



D/1413



D/1284



D/1318



D/805



C/6807



D/1424



D/1366



D/1376



D/1317

ESEMPIO MONTATO
ASSEMBLED EXAMPLE



K/1352



D/854

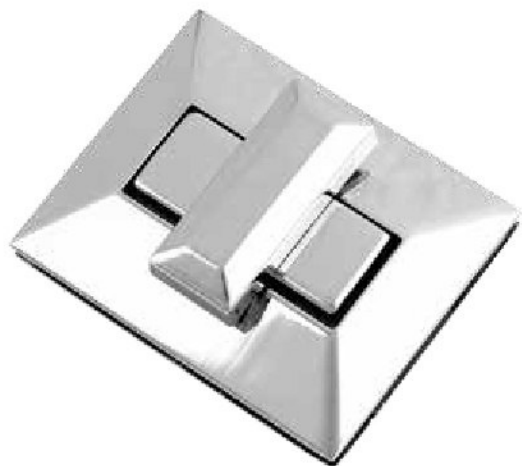

D/1162



D/1239



D/236

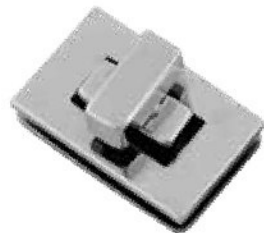

D/557



D/1295

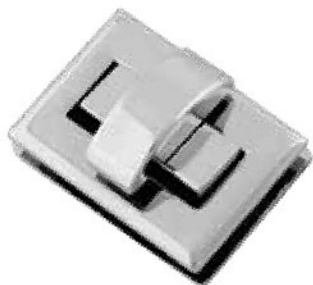

D/183



C/4240



D/1086



D/220



D/457



C/2707/1

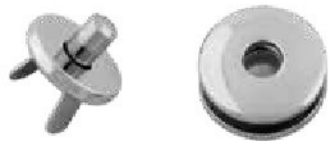

D/398

CHIUSURA A CALAMITA
MAGNET LOCK



C/3979



A/5640



D/1050



D/1163



D/1182



D/1233



C/6805



C/6804





D/1222



D/1184



D/743



D/1375



D/1164



D/1217



ESEMPIO - EXAMPLE



D/1399

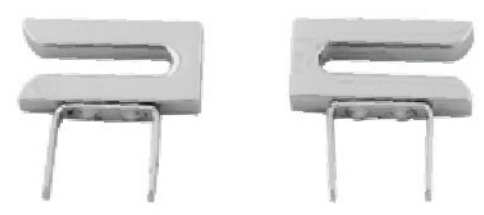

D/112



D/1378



D/1329



D/102



D/1381/25



D/1381/20



C/5400/20



C/5400/30



C/5400/40



K/1681/20

K/1681/28

K/1681/36



C/6175/28



C/6806/30





D/102



D/103



K/439

OTTONE - SOLID BRASS



D/993



ESEMPIO - EXAMPLE



D/1277/10



D/1206/10



D/1208/10



ESEMPIO - EXAMPLE

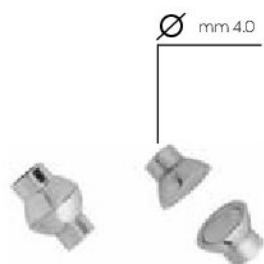

D/1227/4

DISPONIBILE ANCHE IN mm 3-5
ALSO AVAILABLE IN mm 3-5

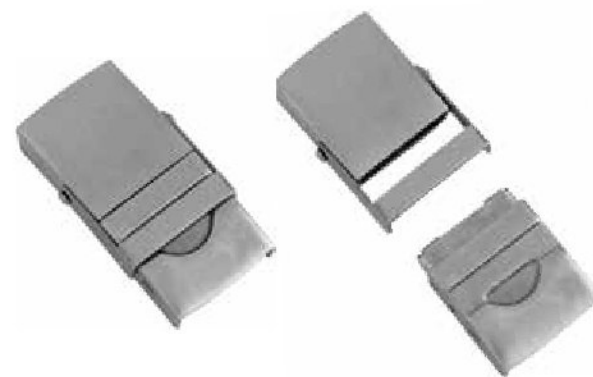

D/1274/14



ESEMPIO - EXAMPLE



C/16727



ESEMPIO - EXAMPLE



K/1657/8

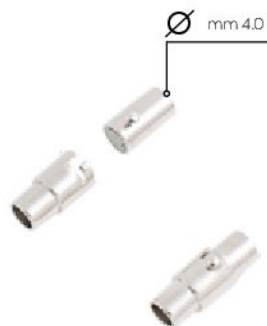

D/1369/4



D/1370/6



D/1320/4



D/1368/4

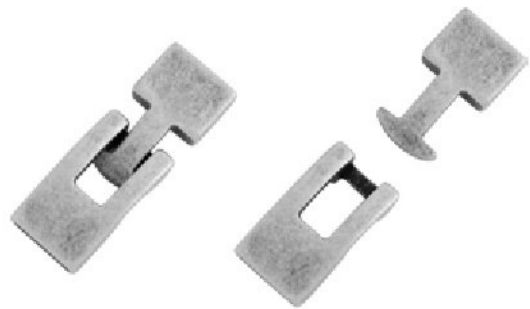

K/1677/10



K/1183/7



K/1643/5



ESEMPIO - EXAMPLE



K/1679/10



D/1367/4



K/1580/15



K/7708

DISPONIBILE ANCHE NELLE MISURE
ALSO AVAILABLE IN THE FOLLOWING SIZES

cm 27 - 30 - 35 - 40 - 45 - 50



A/3942



K/2046/020

ALTRE MISURE A RICHIESTA
OTHER DIMENSIONS ON DEMAND



K/2046
APERTO
OPEN



C/3097/8



C/3097/10



K/2466/1



K/2466/2



.....
FIBBIE  **BUCKLES**
.....



A/1733/16



A/1735/20



A/1736/22



A/1740/40



A/1739/35



A/1738/30



E/2074/40



A/1741/46



A/1742/60



A/7424/15



A/7424/20



A/7424/25



A/7424/35



A/7424/30



A/7424/40



A/7424/50



A/8060/60



A/8689/30



A/8689/25



A/8689/20



A/8689/18



A/8689/16



A/8689/50

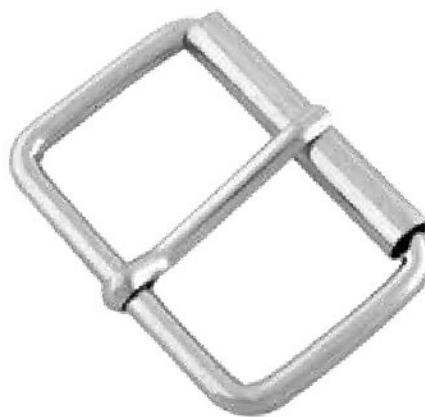

A/8689/40



A/8689/35



A/1726/30



A/1726/36



A/1726/40

DISPONIBILE ANCHE IN mm 50
ALSO AVAILABLE IN mm 50



E/1330/25



E/1330/20



A/1726/20



A/1726/26



D/694/20



D/694/25



D/983/15



D/983/20



D/374/40*

* ARDIGLIONE IN ZAMA - ZINC ALLOY PRONG



D/1263/25



D/1263/20



D/1263/15



D/430/15

DISPONIBILE ANCHE IN mm 10
ALSO AVAILABLE IN mm 10



D/430/20



D/430/25



D/430/30



D/430/35



D/430/40



C/6212/14



C/6212/20



C/3050/20

DISPONIBILI ANCHE IN mm 15 - 25
ALSO AVAILABLE IN mm 15 - 25



C/4271/20

DISPONIBILI ANCHE IN mm 16 - 25
ALSO AVAILABLE IN mm 16 - 25



C/5019/20

DISPONIBILI ANCHE IN mm 16 - 25 - 30
ALSO AVAILABLE IN mm 16 - 25 - 30



C/5300/20

DISPONIBILI ANCHE IN mm 16 - 25 - 30
ALSO AVAILABLE IN mm 16 - 25 - 30



C/3725/25

DISPONIBILI ANCHE IN mm 16 - 20 - 30
ALSO AVAILABLE IN mm 16 - 20 - 30

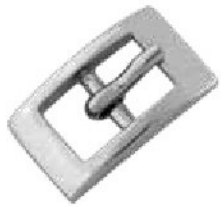

C/5769/10



C/5770/10



C/5772/10



C/6019/10



C/6019/15



C/6019/20



D/1269/10



C/5832/20



C/5832/25



D/736/40



D/736/25



C/6156/15

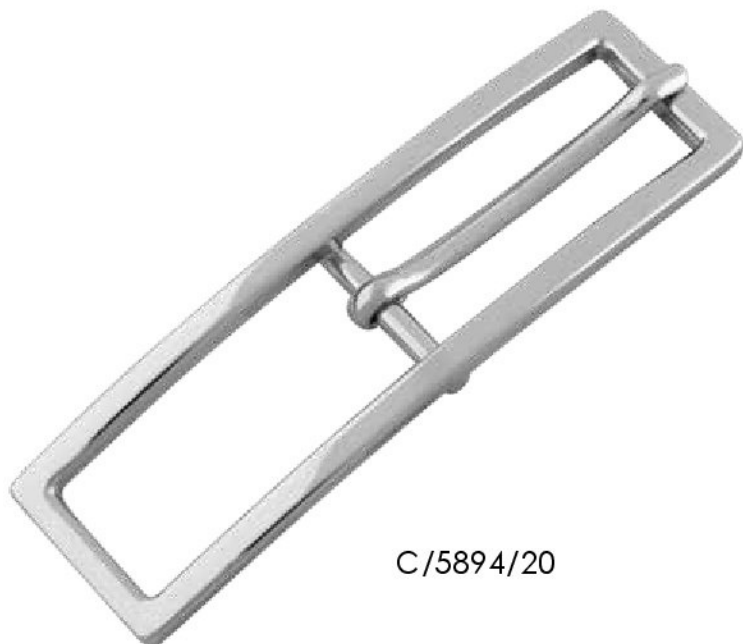

C/5894/20



C/4838/25



C/5298/25

DISPONIBILI ANCHE IN mm 20 - 30
ALSO AVAILABLE IN mm 20 - 30

DISPONIBILI ANCHE IN mm 16 - 20 - 30 - 35
ALSO AVAILABLE IN mm 16 - 20 - 30 - 35



C/5930/25



C/5930/30



C/5930/35



C/5930/40



C/5930/50

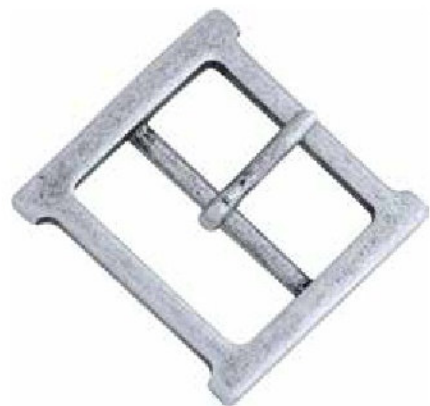

C/6664/30



C/6664/40



C/6667/30



K/1378/40



D/944/30



D/940/40



D/989/30



A/217/40

C/2343/50



K/1293/40



C/5751/60



C/5556/50

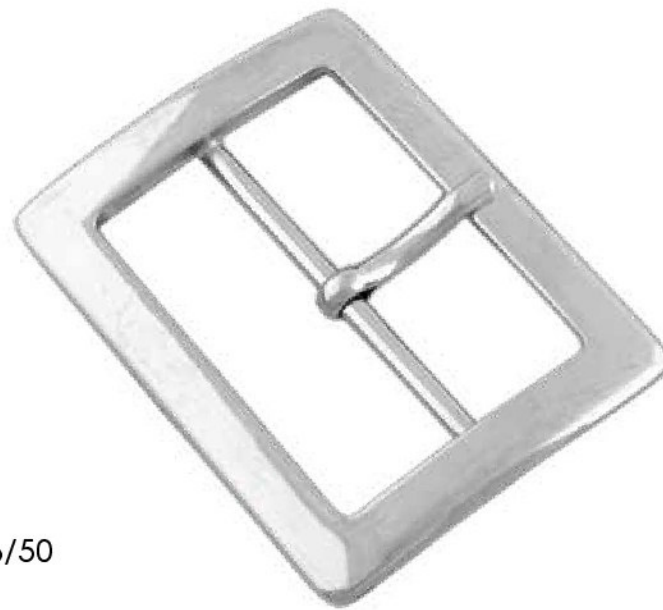



C/6013/16



C/6013/20



C/6013/25



C/6013/30



C/5754/20



C/5754/25



C/6012/16



C/6012/20



C/6012/25



C/5137/15

DISPONIBILE ANCHE IN mm 20
ALSO AVAILABLE IN mm 20



C/5009/20



C/5853/20

DISPONIBILE ANCHE IN mm 12 - 16 - 25
ALSO AVAILABLE IN mm 12 - 16 - 25



C/6110/15*

* ARDIGLIONE IN ZAMA - ZINC ALLOY PRONG



C/5738/25

DISPONIBILE ANCHE IN mm 20
ALSO AVAILABLE IN mm 20



D/1268/15 *



D/1268/20 *



D/1268/25 *

* PER ATTACCO VEDI D/1278
AS HANDLE HOLDER SEE ITEM D/1278



D/1270/15



D/1271/20



C/5225/20

DISPONIBILE ANCHE IN mm 30
ALSO AVAILABLE IN mm 30



C/3279/25

DISPONIBILE ANCHE IN mm 20
ALSO AVAILABLE IN mm 20



A/8541/30

DISPONIBILE ANCHE IN mm 35 - 40
ALSO AVAILABLE IN mm 35 - 40



C/5963/30

DISPONIBILE ANCHE IN mm 25
ALSO AVAILABLE IN mm 25



C/6091/30



C/6072/38



C/5670/15

DISPONIBILE ANCHE IN mm 10
ALSO AVAILABLE IN mm 10



C/5020/20

DISPONIBILE ANCHE IN mm 10 - 16 - 25
ALSO AVAILABLE IN mm 10 - 16 - 25



C/4851/25

DISPONIBILE ANCHE IN mm 15 - 20
ALSO AVAILABLE IN mm 15 - 20



C/5469/16



C/5469/20



C/5469/25

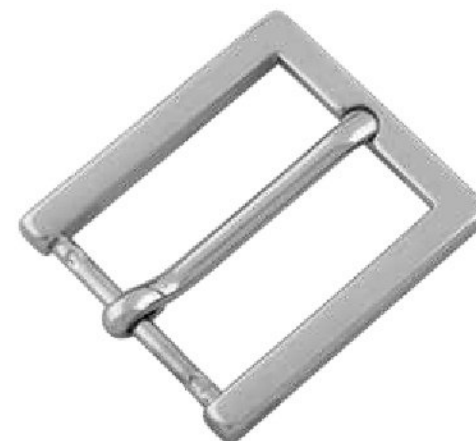

C/5469/30



D/1221/20



D/1221/30



C/5512/30



C/6102/20



C/5307/15



C/5307/20



C/5307/25



C/5307/30



C/4668/25



C/4668/20



C/4668/15

DISPONIBILE ANCHE IN mm 30
ALSO AVAILABLE IN mm 30



C/6399/15



C/6399/20



D/215/30*



D/216/30



C/5521/30



D/1008/30



C/5523/30

* ARDIGLIONE IN ZAMA - ZINC ALLOY PRONG



K/1642/35



K/1641/35



K/1639/35

FINTO RULLO
FAKE ROLLER



K/1626/40

FINTO RULLO
FAKE ROLLER



C/5225/30



D/144/30



D/145/30



C/5738/30



D/213/30



D/214/30*

* ARDIGLIONE IN ZAMA - ZINC ALLOY PRONG



C/5225/35



D/214/35



D/213/35



D/145/35



D/255/35



D/216/35



D/370/35



D/312/35

DISPONIBILE ANCHE IN mm 40
ALSO AVAILABLE IN mm 40



D/1132/35



D/1165/35



D/994/35*

* ARDIGLIONE IN ZAMA - ZINC ALLOY PRONG



D/1131/35



D/215/35*



D/1075/35

DISPONIBILE ANCHE IN mm 30
ALSO AVAILABLE IN mm 30



D/252/35*



D/169/35*



D/1069/35



D/225/35

* ARDIGLIONE IN ZAMA - ZINC ALLOY PRONG



D/1068/40

DISPONIBILE ANCHE IN mm 30 - 35
ALSO AVAILABLE IN mm 30 - 35



D/1069/40



D/994/40



D/314/40

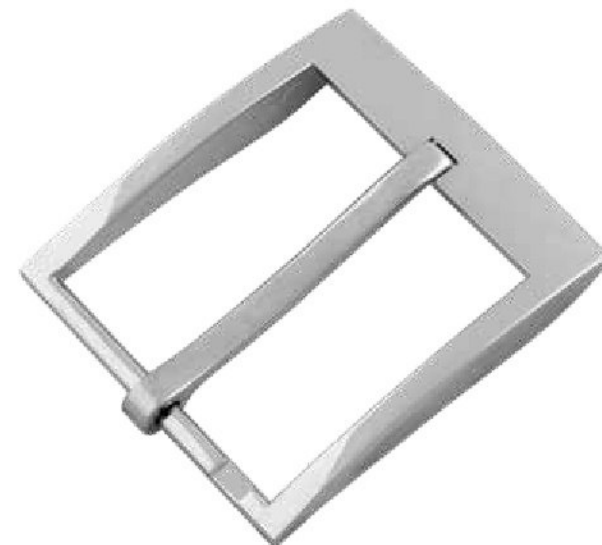

D/145/40



C/5893/35



C/4668/40

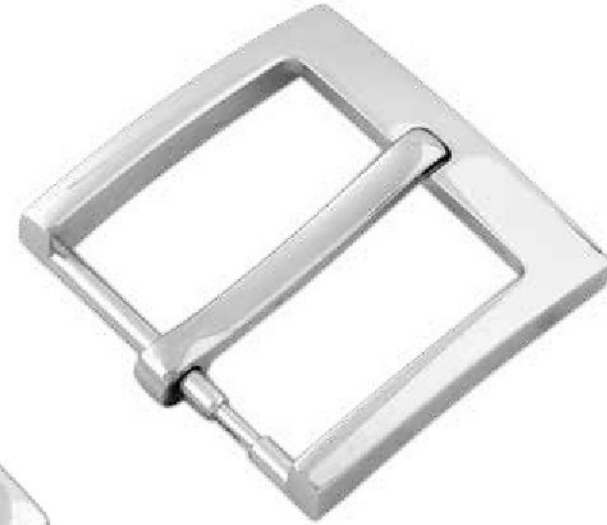

D/255/40*



D/282/40*



D/288/40*

* ARDIGLIONE IN ZAMA - ZINC ALLOY PRONG



C/5779/40

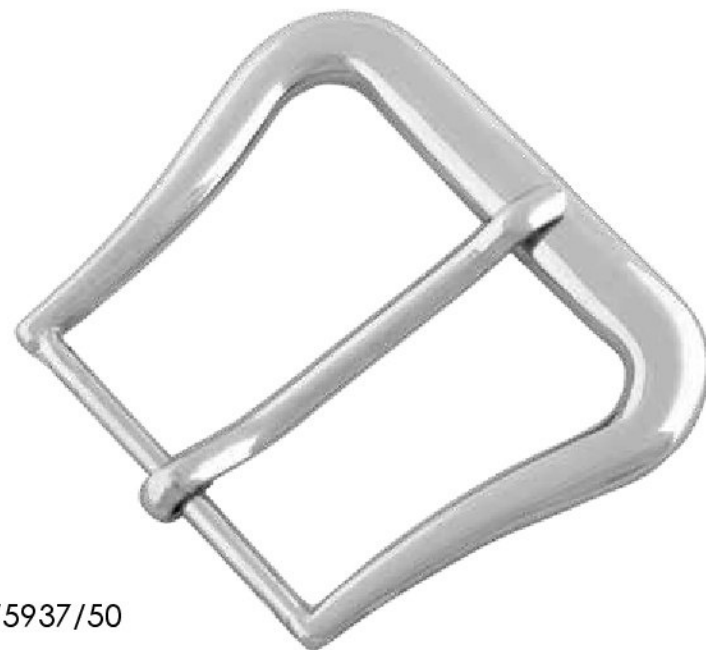

C/5937/50



C/5679/60



C/5830/60



D/1398/20



D/1344/20



D/1343/20



D/1307/30



C/5552/30



C/5555/30



C/5675/30



C/5834/30



C/5551/30



D/1308/30



D/1309/30



D/1310/30



D/1311/30



D/1312/30



D/480/35



D/482/35

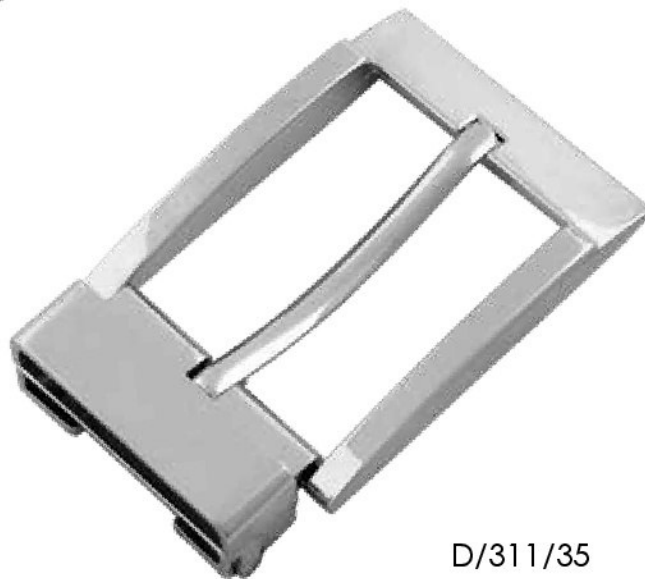

D/311/35



D/308/35



D/309/35



D/1442/35



D/1443/35



D/1418/35



D/1430/35



D/1441/35



D/1324/40



D/1325/40



D/1326/40



K/1263/30



C/5797/40



C/5816/40



ESEMPIO DI PERSONALIZZAZIONE CON SMALTO
EXAMPLES OF CUSTOMIZATION ENAMEL

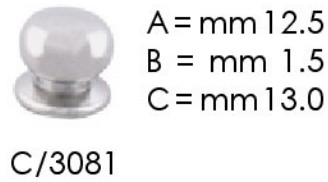
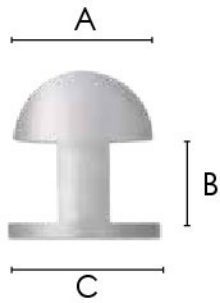

A = mm 12.5
B = mm 1.5
C = mm 13.0



A = mm 9.2
B = mm 5.9
C = mm 12.0



A = mm 8.0
B = mm 5.5
C = mm 12.0



A = mm 7.8
B = mm 3.7
C = mm 8.0



A = mm 7.0
B = mm 4.0
C = mm 10.0



A = mm 6.4
B = mm 3.3
C = mm 10.0



A = mm 6.4
B = mm 4.0
C = mm 7.0



A = mm 5.0
B = mm 3.6
C = mm 10.0



A = mm 5.0
B = mm 3.5
C = mm 7.0



A = mm 6.0
B = mm 3.5
C = mm 9.0

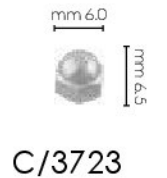

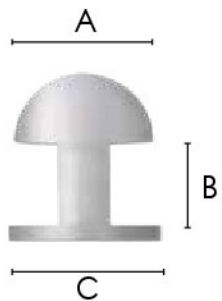

A = mm 5.4
B = mm 2.0



C/5424/1

OLGO mm 2.0
STEM mm 2.0

A = mm 5.4
B = mm 3.0



D/1054

C/5753



A = mm 8.0
B = mm 3.4
C = mm 8.0

A/7279



C/5822



D/1045



M/970/6



M/720/7

DISPONIBILE ANCHE IN mm 5 - 10 - 12
ALSO AVAILABLE IN mm 5 - 10 - 12

VITI DA REGISTRO - SCREW

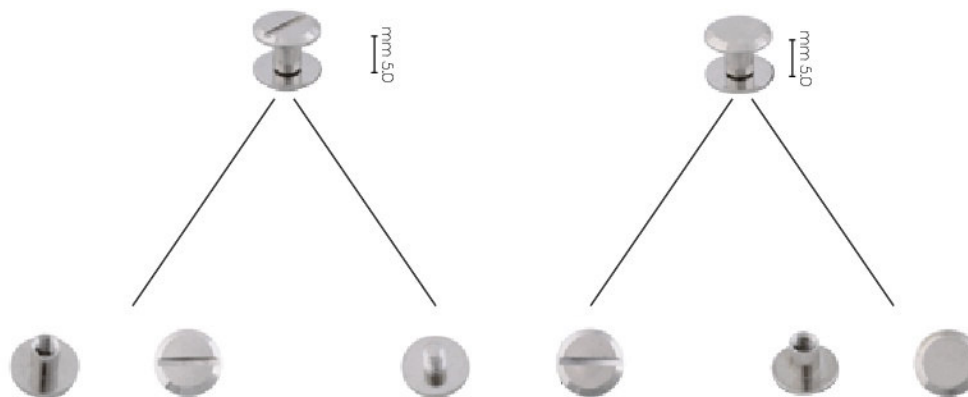

A/9521/2

FEMMINA
FEMALE

A/9521/3

MASCHIO
MALE

A/9521/5

FEMMINA
FEMALE



C/6053/9



K/1158/9



K/1158/12



C/6085/15



D/519



C/6760



C/5895/7



C/5895/14



C/5895/16



K/1159



C/5939



C/5940



C/5051



C/6195



C/4081



C/6084



C/5182



C/5159/1



C/5727



C/6562/7



C/6562/10



C/6266/6



C/6266/9



C/6266/11



C/6082/9



C/6082/12



C/6082/14



K/1615/10



C/6079/9



C/6079/12



C/6079/16



K/1615/12



C/6476/7



C/6476/9



C/6476/12



C/6157/7



C/6157/12



C/6157/14

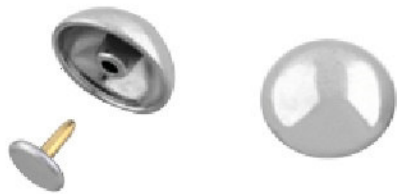

K/1251

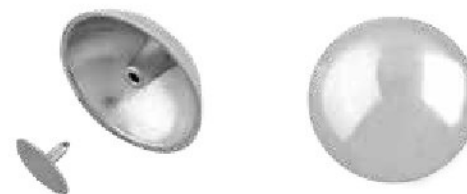

K/1277/25



D/519/1

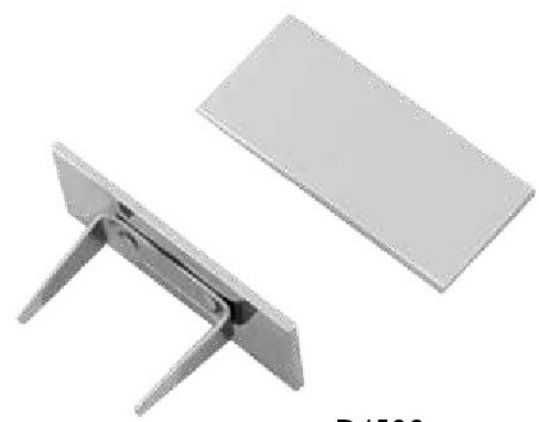

D/538

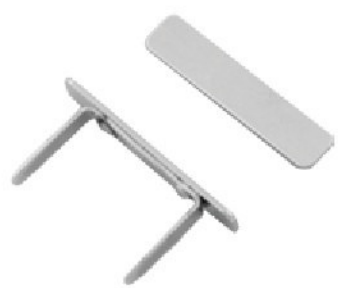

D/827



D/826





D/935/10



D/954/9



D/848/12



A/8280/15



D/990



D/991



D/739



D/1202/12



D/1202/17



D/1454



A/7549

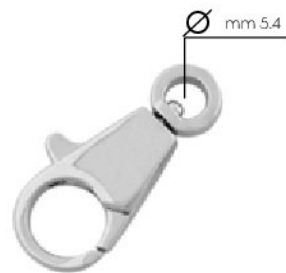

D/279



D/192



D/775/10



D/198/15



D/1033/17



D/1033/20



D/1360



D/1364



D/1074



D/1071/17



C/5140/15



C/5140/20

DISPONIBILE ANCHE IN mm 25
ALSO AVAILABLE IN mm 25



D/190/17



C/3118/20



D/731



D/159



D/1212



D/520



D/152/1



D/152/4



D/1283/20



D/1283/25



D/152



C/5843



A/4950/3



D/135/12



D/128/20



D/249/15



D/249/20



D/1377/10



D/1377/16



D/1377/20



D/1365/10



D/518



D/672



D/664/20



D/664/25



D/512/17



D/512/20



D/512/25



D/669



D/670/17



D/670/20



D/670/25



D/337/40



D/337/30



D/337/25



D/337/20



D/1087/15



D/1087/20

DISPONIBILE ANCHE IN mm 25 - 30
ALSO AVAILABLE IN mm 25 - 30



D/875/30

DISPONIBILE ANCHE IN mm 20 - 25 - 40
ALSO AVAILABLE IN mm 20 - 25 - 40



D/419/15



D/419/20

DISPONIBILE ANCHE IN mm 30
ALSO AVAILABLE IN mm 30



D/419/25



D/242/40



D/242/30



D/242/25



D/321



A/9700/25

DISPONIBILE ANCHE IN mm 40
ALSO AVAILABLE IN mm 40



D/209/20



D/209/25



D/427/20

DISPONIBILE ANCHE IN mm 25
ALSO AVAILABLE IN mm 25



D/394/20



D/385/20



D/385/25

DISPONIBILE ANCHE IN mm 25 - 30
ALSO AVAILABLE IN mm 25 - 30



D/1347/25



C/5505/10



D/122/15



D/436/15



D/436/20



D/158



D/1249



A/1204/0



A/1204/1



C/1906/20



C/1906/30



C/1907/20



C/1907/30



D/257



D/258/25



D/258/40



D/366/25



D/359/37



D/359/31



D/359/25



D/379



D/883



K/1603/16



D/372/20



D/298



D/299



D/372/30

DISPONIBILE ANCHE IN mm 35
ALSO AVAILABLE IN mm 35



D/372/40



D/372/50



D/372/60



VL 60



VL 70



VL 80



VL 50



VL 40

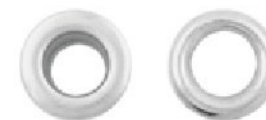

VL 31



VL 21

OCCHIELLI - EYELETS			
ARTICOLI - ITEMS	INT (mm)	EST. (mm)	ALTEZZA - HEIGHT (mm)
VL 21	6,8	12,7	6,8
VL 31	8	15	6,5
VL 40	9,5	18,5	6,8
VL 50	11,5	22,5	8,5
VL 60	14,8	24	7
VL 70	15	30	9
VL 80	19	34	9,3



VL 80P



VL 70P



VL 60P



VL 50P



VL 40P



VL 31P



VL 60TB



VL 70TB



VL 80TB

OCCHIELLI - EYELETS			
ARTICOLI - ITEMS	Ø INT (mm)	Ø EST. (mm)	ALTEZZA - HEIGHT (mm)
VL 31 P	8	15	6,5
VL 40 P	9,5	18,5	6,2
VL50 P	12	22,5	7
VL 60 P	14	25,5	7
VL 70 P	15,4	28,5	7,5
VL 80 P	20	38	9
VL 60 TB	14	25	6,7
VL 70 TB	15,4	28,5	8
VL 80 TB	20	38	9,5

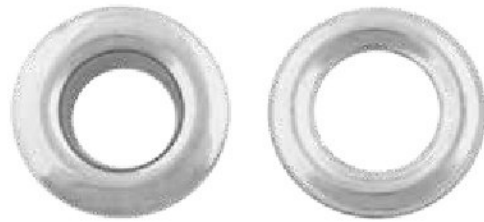

C/4935



C/4934

OCCHIELLI - EYELETS			
ARTICOLI - ITEMS	Ø INT (mm)	Ø EST. (mm)	ALTEZZA - HEIGHT (mm)
C/4934	9	20	7,4
C/4935	15	29	9

OCCHIELLI DOUBLE FACE - DOUBLE FACE EYELETS

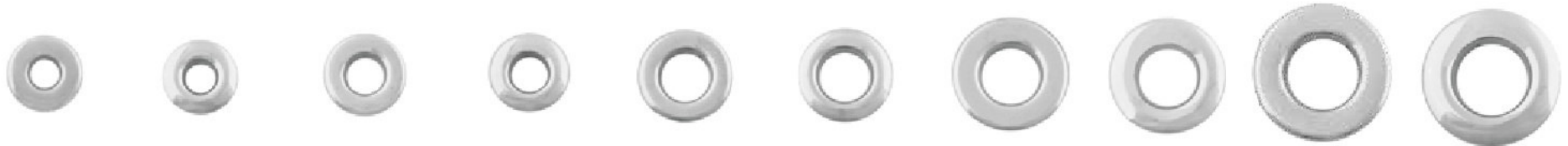

D/060/2P

D/0602/2

D/070/2P

D/0702/2

D/080/2P

D/0802/2

D/090/2P

D/0902/2

D/100/2P

D/102/2



D/152/2



D/170/2P



D/172/2

OCCHIELLI - EYELETS		
ARTICOLI - ITEMS	Ø INT (mm)	Ø EST. (mm)
D 060/2P (D0602/2)	5	12
D 070/2P (D0702/2)	6	13
D 080/2P (D0802/2)	8	15
D 090/2P (D0902/2)	9,5	18,5
D 100/2P (D102/2)	12	22
(D152/2)	14	25,5
D 170/2P (D172/2)	15	28,5

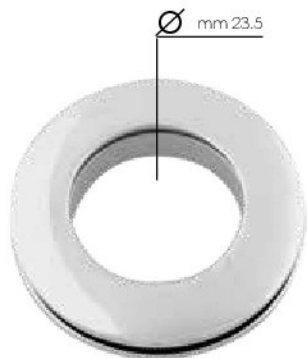

C/1829



C/1828



C/3046

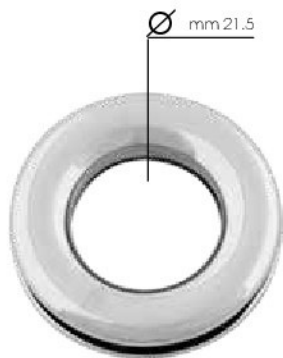

C/3813

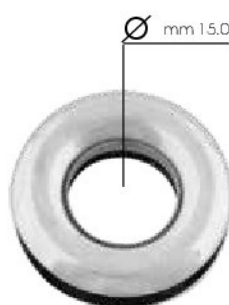

C/2450

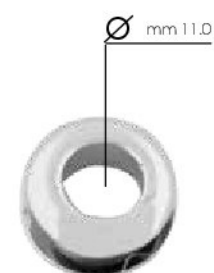

C/2451

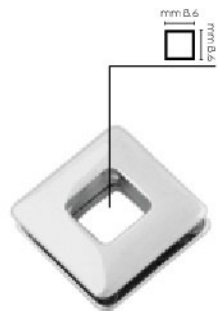

C/5712

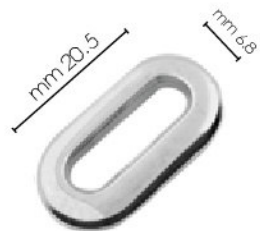

C/2979

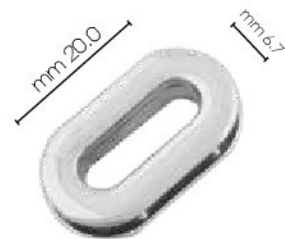

C/6076/20

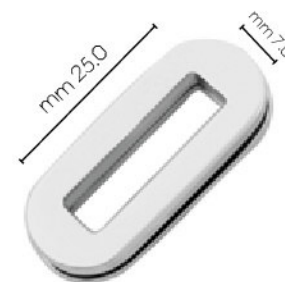

D/550/25

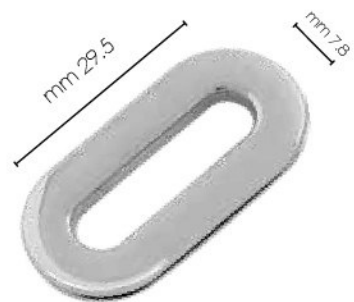

D/1062/30

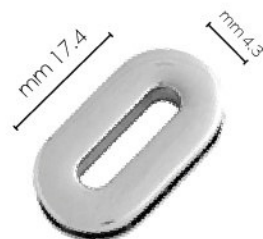

D/1280/17

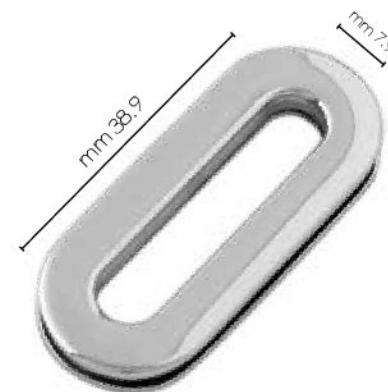

D/1062/38



A/3693/40



A/3693/35



A/3693/30



A/3693/25



A/3693/22



A/3693/20



A/3693/18



A/3693/16



A/3693/14



A/3693/10



C/5316/20



C/5316/25



C/5153/30



C/5153/35

DISPONIBILE ANCHE IN: mm 30
ALSO AVAILABLE IN: mm 30

DISPONIBILE ANCHE IN: mm 40
ALSO AVAILABLE IN: mm 40



C/5337



C/6283/30

DISPONIBILE ANCHE IN: 26 mm
ALSO AVAILABLE IN: 26 mm



C/4208/30



C/4208/25



C/4208/22



A/7850/8



A/3815/10

DISPONIBILE ANCHE IN:
ALSO AVAILABLE IN:
mm 18 - 20 - 25 - 34



A/3815/16



A/3815/18



A/3815/20



A/3815/25



A/3815/34



C/6605

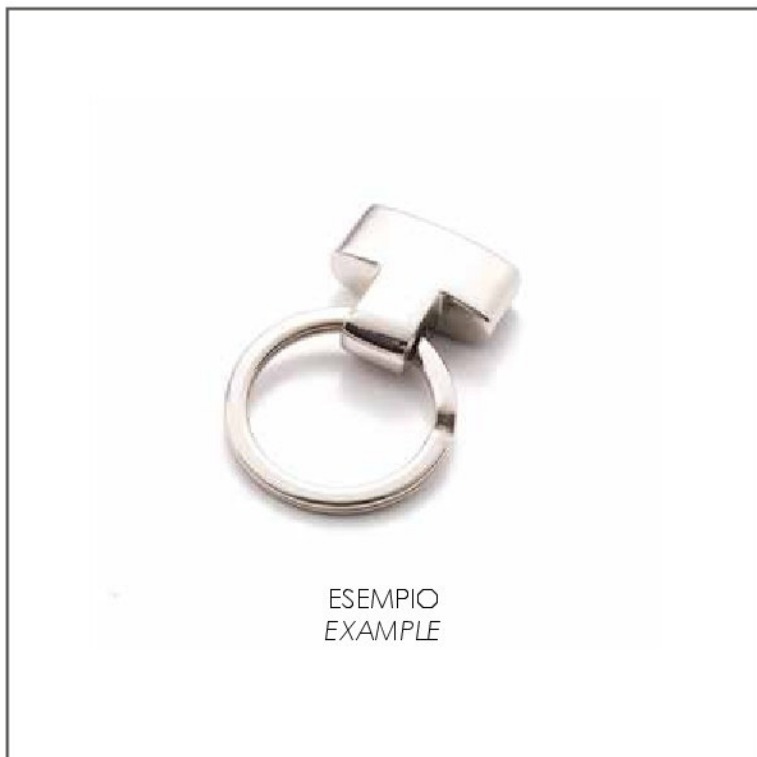

D/230/20



C/6797/22



D/200/30



D/187/22

DISPONIBILE ANCHE IN: mm 35
ALSO AVAILABLE IN: mm 35



A/1678



D/323/4



D/323/6



K/927/6



A/5914/6



D/284



APERTO
OPEN



D/113/70

DISPONIBILE ANCHE IN:
ALSO AVAILABLE IN:
mm 75



D/283



D/286

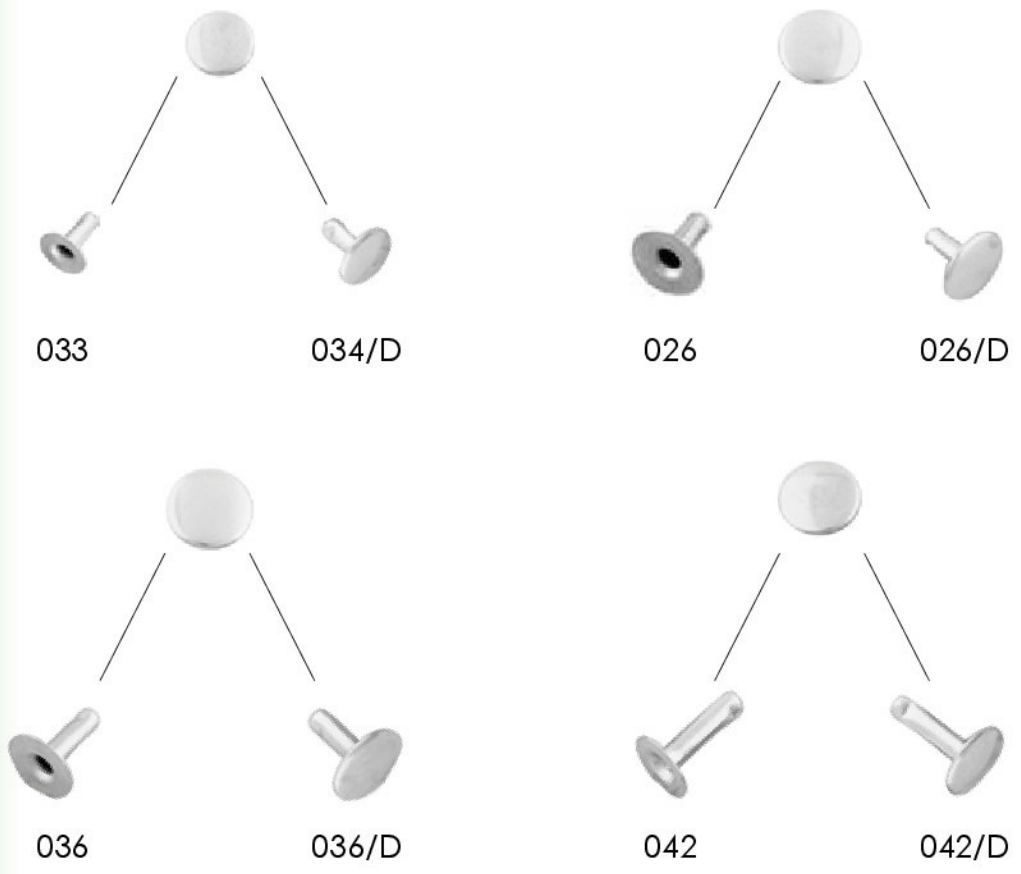
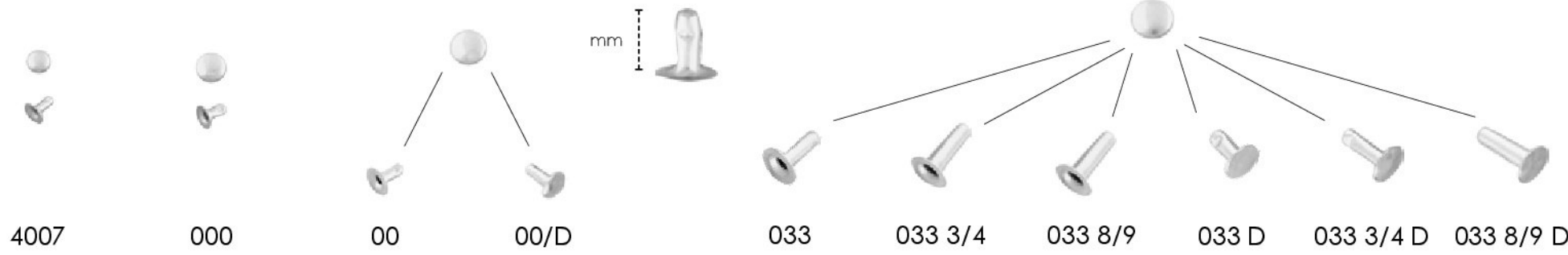

OLGHI - STEMS	
ARTICOLI - ITEMS	LUNGHEZZA - LENGHT (mm)
4007	5
000	5
00 - 00/D	6
033 - 033/D	7,5
033 3/4 - 033 3/4 D	9
033 8/9 - 033 8/9 D	11
034/D	9,5
026 - 026/D	9
036 - 036/D	11
042 - 042/D	14
TESTE - CAPS	
ARTICOLI - ITEMS	MISURA - SIZE (mm)
4007	Ø 4
000	Ø 5
00	Ø 6
033	Ø 7
034	Ø 9
026	Ø 11
036	Ø 11
042	Ø 11



00 TS

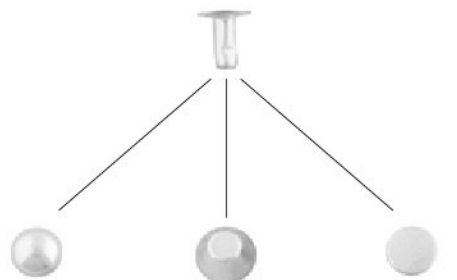

033 TS

033 TC

033 TP



034 TS

TESTE - CAPS

ARTICOLI - ITEMS	MISURA - SIZE (mm)
00 TS	Ø 5,5
033 TS	Ø 6,9
033 TC	Δ 5 - 7,9
033 TP	Ø 6,8
034 TS	Ø 8,9
036 TS	Ø 11
036 TC	Δ 7,3 - 10,8
037 TS	Ø 13,8
037 TC	Δ 8 - 14
A/6223/1	Ø 9
M/469	Ø 9
033 T	Ø 7
A/6221/1	Ø 11
M/457	Ø 11
036 T	Ø 11
OLGHI - STEMS	
ARTICOLI - ITEMS	LUNGHEZZA - LENGHT (mm)
M/469/1	7
M/457/1	10

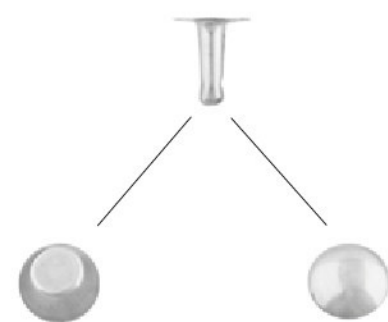

036 TC

036 TS

A/6223/1

033 T



M/469/1

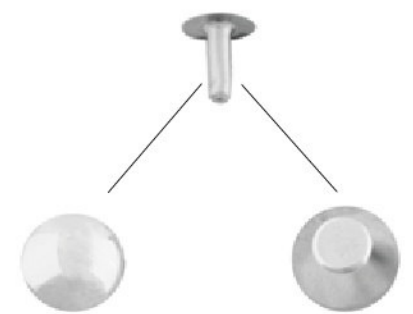

037 TS

037 TC

A/6221/2

036 T



M/457/1



A/3694/25

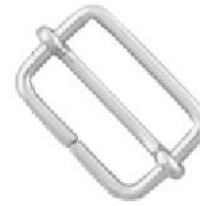

A/3694/20



A/3694/16



A/3694/40



A/3694/35



A/3694/30



C/1852/50



C/1852/40



C/1852/25



E/1379/20



E/1379/22



E/1379/25



E/1379/30



E/1379/35



E/1379/40



A/6554/30



A/6554/25



A/6554/20



C/5898/20



C/5898/25



C/5898/50



C/5898/40



C/5898/30



C/5047/15



C/5047/20



C/5047/25



D/722/40



D/722/30



D/722/25



D/722/20



C/5458/40



C/5458/30



X/14/14/....
GRAFFETTA 502
CLAMP 502



A/3468/4



C/4210



C/5324



A/2755



A/6050/5



A/6050/10





C/5164/1



C/5163/1



C/5371/1



C/2486/0



C/5247/1



C/5313/1



C/5604/1



C/5605/1

CURSORE mm 6.0
SLIDER mm 6.0



C/6160/1



E/3673/0



C/2318/0



SOLO CURSORE E/3937
SLIDER ONLY E/3937



K/1353/1



D/490/1



D/896/1



D/1374



D/1457



D/1458



D/1453



D/1453/1



D/1455



D/1455/1



D/1452



D/1452/1



D/1209/1



D/606/1



D/1055/1



D/1055



D/1279



D/1258



D/1209



D/936



C/6839/7



D/1456/9



C/5163



D/490



C/5605/2



D/1301/5



D/1301/8



D/1386/5



D/1385/5



D/1293/8



D/1302/100 GRANA mm 5 - SIZE mm 5
VARI COLORI - VARIOUS COLOURS

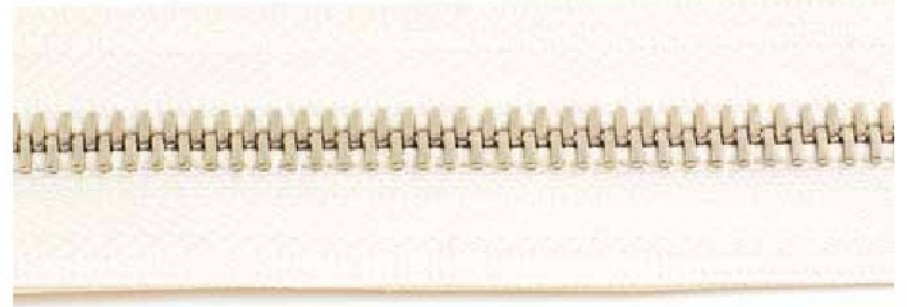

D/1303/100 GRANA mm 8 - SIZE mm 8
VARI COLORI - VARIOUS COLOURS



ESEMPI - EXAMPLES



X/771/121/... CERNIERA LAMPO IN NYLON - NYLON ZIPPER



U/282

U/651/...

FUSTELLA OVALE:
da mm 6 a mm 30
OVALS HAND PUNCHES:
from mm 6 up to mm 30

U/251/...

FUSTELLA TONDA:
da Ø mm 2 a Ø mm 28
ROUND HAND PUNCHES:
from Ø mm 2 up to Ø mm 28



U/294



U/204/7
(POLLICI - INCHES)

DISPONIBILE ANCHE IN : 8 - 9
ALSO AVAILABLE IN: 8 - 9



U/741



U/350

TRINCETTO - CUTTER



U/144

TRINCETTO - HAND KNIVES



U/143

TRINCETTO - HAND KNIVES

U/246

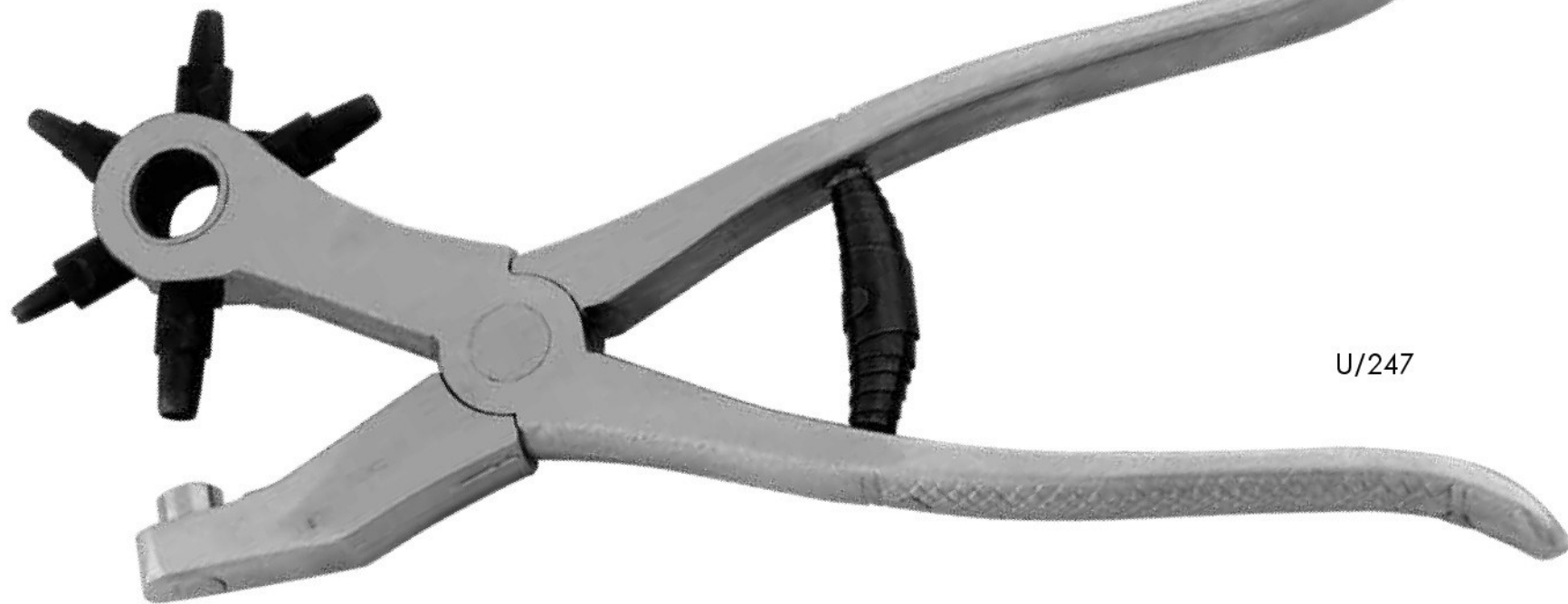

U/247

U/198

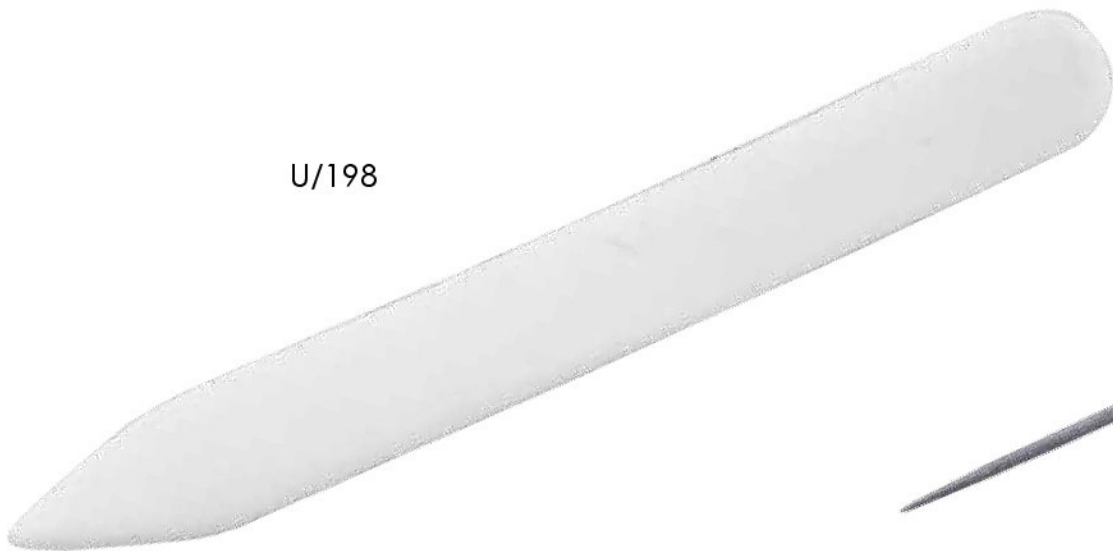

U/151/60



U/442



U/240/150



U/749/002

TORCHIETTO - VARIE DIMENSIONI
HAND MACHINE - VARIOUS DIMENSION

IMMAGINE IN DIMENSIONI RIDOTTE
REDUCED SIZE IMAGE



U/374

INFILA CURSORI
ZIP MACHINE



X/172/044/...
X/172/045/...







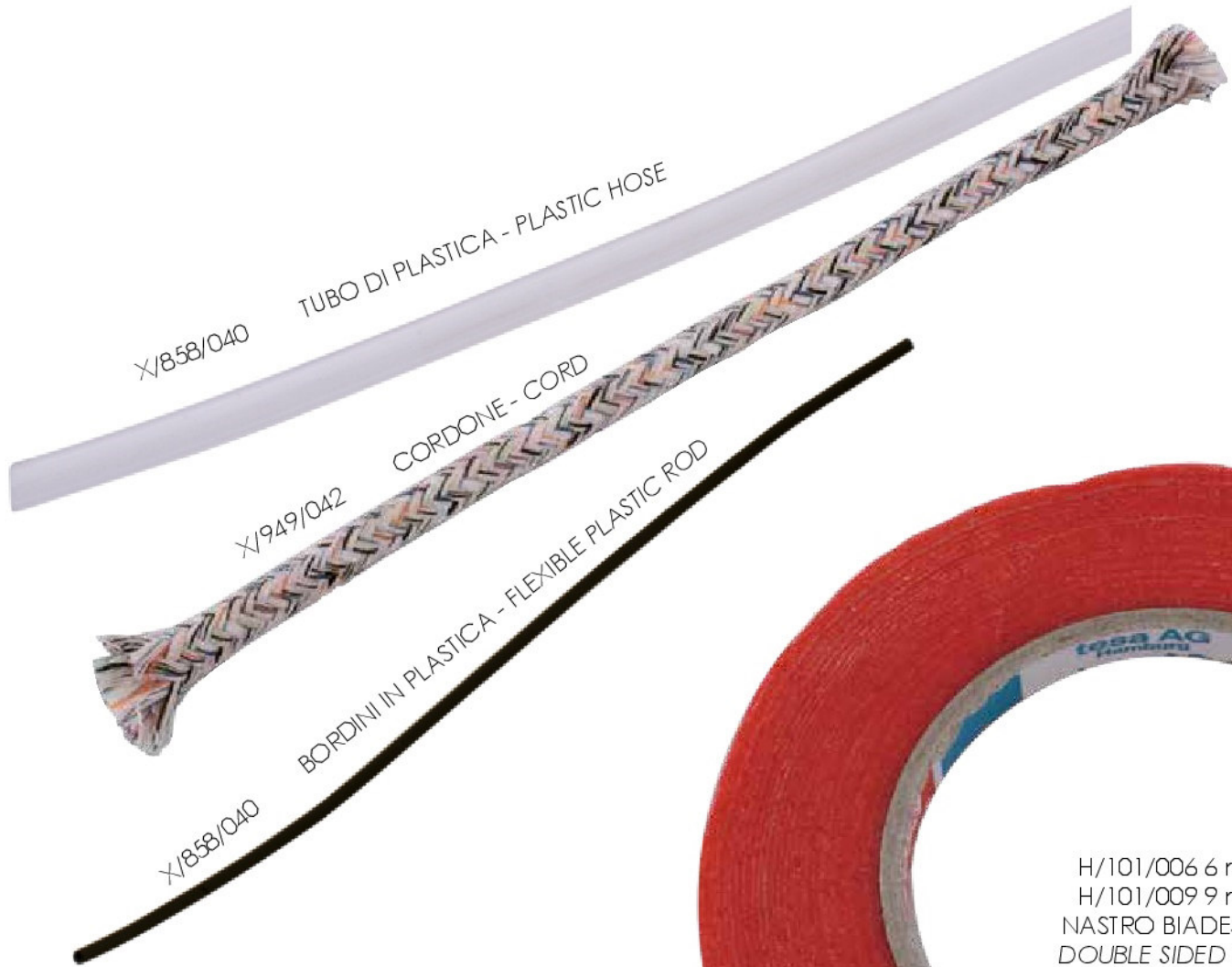

















SALPA - REGENERATED LEATHER



X/964/046/...
SUGHERITE
REGENERATED CORK



BOTTONI ALFA - ALFA SNAPS

	A	A ¹	A ²	A ³	B	C	D
0	 mm 10	 mm 8,8			 mm 9,30		
0/1	 mm 12	 mm 10,5	 mm 12,5		 mm 11		
1	 mm 13	 mm 12,5	 mm 14	 mm 15,5	 mm 12,5		
2	 mm 18	 mm 15,5	 mm 17		 mm 16		

I gambi delle teste sono disponibili anche nella versione "gambo lungo".
On request tops available with longer prongs

**FINITURE
STANDARD**

Nichelato



Ottonato



Bronzato



Rame
vecchio



Nichel
nero



Argento
antico



















Verniciato



Marcato



BOTTONI KAPPA - KAPPA SNAPS

N	A	A ¹	A ²	A ³	A ⁴	B	C	D
0	 Ø 10,5	 Ø 12,5				 Ø 10,60	 C  C3	 D
0/1						 Ø 12,00		
1	 Ø 12,5	 Ø 14	 Ø 15,5	 Ø 17		 Ø 14,00		

Varianti
d'assemblaggio
bottone Kappa 1



Maschio C
Maschio C1

Maschio C5

Contromaschio Kappa 1D

Kappa 1C5

Vite

Testa gambo lungo

Ranella

Kappa 1C

Kappa 1B

La serie Kappa 1/A³ B-C-D è disponibile anche in acciaio inox

**FINITURE
STANDARD**

Nichelato



Ottonato



Bronzato



Rame
vecchio



Nichel
nero



Argento
antico



Verniciato



Marcato





ARTICOLI PUNZONATI
EMBOSSED LOGO



ARTICOLI LASERATI
LOGO BY LASER



A series of horizontal lines for writing, spaced evenly down the page.



A series of horizontal lines for writing, spanning the width of the page.

ARTICOLO - ITEMS	DESCRIZIONE - DESCRIPTION	MATERIALE	MATERIAL	CAT	PG
A					
A/0217/040	FIBBIA DOPPIA - BUCKLE	ZAMA	ZINC ALLOY	8	12
A/1204/000	MOSCHETTONE - DOG CLIP	ZAMA	ZINC ALLOY	12	13
A/1204/001	MOSCHETTONE - DOG CLIP	ZAMA	ZINC ALLOY	12	13
A/1678/000	PORTACHIAVI - KEY CASE FITTING	FERRO	IRON	16	3
A/1726/020	FIBBIA A RULLO - ROLLER BUCKLE	FERRO	IRON	8	4
A/1726/026	FIBBIA A RULLO - ROLLER BUCKLE	FERRO	IRON	8	4
A/1726/030	FIBBIA A RULLO - ROLLER BUCKLE	FERRO	IRON	8	4
A/1726/036	FIBBIA A RULLO - ROLLER BUCKLE	FERRO	IRON	8	4
A/1726/040	FIBBIA A RULLO - ROLLER BUCKLE	FERRO	IRON	8	4
A/1726/050	FIBBIA A RULLO - ROLLER BUCKLE	FERRO	IRON	8	4
A/1733/016	FIBBIA A RULLO - ROLLER BUCKLE	FERRO	IRON	8	1
A/1735/020	FIBBIA A RULLO - ROLLER BUCKLE	FERRO	IRON	8	1
A/1736/022	FIBBIA A RULLO - ROLLER BUCKLE	FERRO	IRON	8	1
A/1738/030	FIBBIA A RULLO - ROLLER BUCKLE	FERRO	IRON	8	1
A/1739/035	FIBBIA A RULLO - ROLLER BUCKLE	FERRO	IRON	8	1
A/1740/040	FIBBIA A RULLO - ROLLER BUCKLE	FERRO	IRON	8	1
A/1741/046	FIBBIA A RULLO - ROLLER BUCKLE	FERRO	IRON	8	1
A/1742/060	FIBBIA A RULLO - ROLLER BUCKLE	FERRO	IRON	8	1
A/2755/000	FASCETTA - CLAMP	FERRO	IRON	19	1
A/3468/004	FASCETTA - CLAMP	FERRO	IRON	19	1
A/3518/001	CHIUSURA TIC TUC - LOCK	FERRO	IRON	6	1
A/3526/000	CHIUSURA TIC TUC - LOCK	FERRO	IRON	6	1
A/3528/000	CHIUSURA TIC TUC - LOCK	FERRO	IRON	6	1
A/3693/010	PASSANTE - KEEPER	FERRO	IRON	15	1
A/3693/014	PASSANTE - KEEPER	FERRO	IRON	15	1
A/3693/016	PASSANTE - KEEPER	FERRO	IRON	15	1
A/3693/018	PASSANTE - KEEPER	FERRO	IRON	15	1
A/3693/020	PASSANTE - KEEPER	FERRO	IRON	15	1
A/3693/022	PASSANTE - KEEPER	FERRO	IRON	15	1
A/3693/025	PASSANTE - KEEPER	FERRO	IRON	15	1

ARTICOLO - ITEMS	DESCRIZIONE - DESCRIPTION	MATERIALE	MATERIAL	CAT	PG
A/3693/030	PASSANTE - KEEPER	FERRO	IRON	15	1
A/3693/035	PASSANTE - KEEPER	FERRO	IRON	15	1
A/3693/040	PASSANTE - KEEPER	FERRO	IRON	15	1
A/3694/016	SCORREVOLE - SLIDER WITH ADJUSTABLE BAR	FERRO	IRON	18	1
A/3694/020	SCORREVOLE - SLIDER WITH ADJUSTABLE BAR	FERRO	IRON	18	1
A/3694/025	SCORREVOLE - SLIDER WITH ADJUSTABLE BAR	FERRO	IRON	18	1
A/3694/030	SCORREVOLE - SLIDER WITH ADJUSTABLE BAR	FERRO	IRON	18	1
A/3694/035	SCORREVOLE - SLIDER WITH ADJUSTABLE BAR	FERRO	IRON	18	1
A/3694/040	SCORREVOLE - SLIDER WITH ADJUSTABLE BAR	FERRO	IRON	18	1
A/3697/005	BORCHIA - STUD	FERRO	IRON	3	1
A/3697/007	BORCHIA - STUD	FERRO	IRON	3	1
A/3697/009	BORCHIA - STUD	FERRO	IRON	3	1
A/3697/012	BORCHIA - STUD	FERRO	IRON	3	1
A/3697/014	BORCHIA - STUD	FERRO	IRON	3	1
A/3697/016	BORCHIA - STUD	FERRO	IRON	3	1
A/3697/018	BORCHIA - STUD	FERRO	IRON	3	1
A/3697/020	BORCHIA - STUD	FERRO	IRON	3	1
A/3697/022	BORCHIA - STUD	FERRO	IRON	3	1
A/3697/024	BORCHIA - STUD	FERRO	IRON	3	1
A/3698/007	BORCHIA - STUD	FERRO	IRON	3	1
A/3698/009	BORCHIA - STUD	FERRO	IRON	3	1
A/3698/012	BORCHIA - STUD	FERRO	IRON	3	1
A/3698/014	BORCHIA - STUD	FERRO	IRON	3	1
A/3698/018	BORCHIA - STUD	FERRO	IRON	3	1
A/3698/022	BORCHIA - STUD	FERRO	IRON	3	1
A/3815/010	ANELLO BRISE' - SPRING RING	ACCIAIO	STEEL	16	1
A/3815/016	ANELLO BRISE' - SPRING RING	ACCIAIO	STEEL	16	1
A/3815/018	ANELLO BRISE' - SPRING RING	ACCIAIO	STEEL	16	1
A/3815/020	ANELLO BRISE' - SPRING RING	ACCIAIO	STEEL	16	1
A/3815/025	ANELLO BRISE' - SPRING RING	ACCIAIO	STEEL	16	1
A/3815/034	ANELLO BRISE' - SPRING RING	ACCIAIO	STEEL	16	1

ARTICOLO - ITEMS	DESCRIZIONE - DESCRIPTION	MATERIALE	MATERIAL	CAT	PG
A/3942/000	CERNIERA A MOLLA - PAK PAK FRAME	ACCIAIO	STEEL	7	1
A/4486/020	ATTACCO CON SPINA FILETTATA - HANDLE HOLDER	ZAMA	ZINC ALLOY	2	3
A/4486/025	ATTACCO CON SPINA FILETTATA - HANDLE HOLDER	ZAMA	ZINC ALLOY	2	3
A/4950/003	MOSCHETTONE - DOG CLIP	ZAMA	ZINC ALLOY	12	5
A/4999/020	ATTACCO CON SPINA FILETTATA - HANDLE HOLDER	ZAMA	ZINC ALLOY	2	3
A/5640/000	CHIUSURA CON GIRELLO - LOCK	ZAMA	ZINC ALLOY	6	8
A/5811/020	ATTACCO - HANDLE HOLDER	ZAMA	ZINC ALLOY	2	2
A/5914/006	PORTACHIAVI - KEY CASE FITTING	FERRO	IRON	16	3
A/6050/005	FASCETTA - CLAMP	OTTONE	SOLID BRASS	19	1
A/6050/010	FASCETTA - CLAMP	OTTONE	SOLID BRASS	19	1
A/6161/020	ATTACCO - HANDLE HOLDER	ZAMA	ZINC ALLOY	2	1
A/6221/002	RIVETTO - RIVET	FERRO	IRON	17	2
A/6223/001	RIVETTO - RIVET	FERRO	IRON	17	2
A/6554/020	SCORREVOLE - SLIDER WITH FIXED BAR	ZAMA	ZINC ALLOY	18	3
A/6554/025	SCORREVOLE - SLIDER WITH FIXED BAR	ZAMA	ZINC ALLOY	18	3
A/6554/030	SCORREVOLE - SLIDER WITH FIXED BAR	ZAMA	ZINC ALLOY	18	3
A/6652/100	CATENA - CHAIN	OTTONE	SOLID BRASS	4	3
A/6747/000	PUNTALE FILETTATO - TIP THREADED	ZAMA	ZINC ALLOY	2	12
A/7279/000	GEMELLO A PRESSIONE - STUD	OTTONE	SOLID BRASS	9	2
A/7375/000	MOLLA A CALAMITA - MAGNETIC LOCK	OTTONE + FERRO	BRASS + IRON	5	1
A/7376/000	MOLLA A CALAMITA - MAGNETIC LOCK	OTTONE + FERRO	BRASS + IRON	5	1
A/7424/015	FIBBIA A RULLO - ROLLER BUCKLE	FERRO	IRON	8	2
A/7424/020	FIBBIA A RULLO - ROLLER BUCKLE	FERRO	IRON	8	2
A/7424/025	FIBBIA A RULLO - ROLLER BUCKLE	FERRO	IRON	8	2
A/7424/030	FIBBIA A RULLO - ROLLER BUCKLE	FERRO	IRON	8	2
A/7424/035	FIBBIA A RULLO - ROLLER BUCKLE	FERRO	IRON	8	2
A/7424/040	FIBBIA A RULLO - ROLLER BUCKLE	FERRO	IRON	8	2
A/7424/050	FIBBIA A RULLO - ROLLER BUCKLE	FERRO	IRON	8	2
A/7549/000	MOSCHETTONE - DOG CLIP	ZAMA	ZINC ALLOY	12	2
A/7850/008	ANELLO BRISE' - SPRING RING	FERRO	IRON	16	1
A/7850/018	ANELLO BRISE' - SPRING RING	FERRO	IRON	16	1

ARTICOLO - ITEMS	DESCRIZIONE - DESCRIPTION	MATERIALE	MATERIAL	CAT	PG
A/7850/020	ANELLO BRISE' - SPRING RING	FERRO	IRON	16	1
A/7850/025	ANELLO BRISE' - SPRING RING	FERRO	IRON	16	1
A/7850/034	ANELLO BRISE' - SPRING RING	FERRO	IRON	16	1
A/8060/060	FIBBIA A RULLO - ROLLER BUCKLE	FERRO	IRON	8	2
A/8280/015	MOSCHETTONE - DOG CLIP	ZAMA	ZINC ALLOY	12	1
A/8541/030	MEZZA FIBBIA - BUCKLE	ZAMA	ZINC ALLOY	8	17
A/8541/035	MEZZA FIBBIA - BUCKLE	ZAMA	ZINC ALLOY	8	17
A/8541/040	MEZZA FIBBIA - BUCKLE	ZAMA	ZINC ALLOY	8	17
A/8689/016	FIBBIA A RULLO - ROLLER BUCKLE	FERRO	IRON	8	3
A/8689/018	FIBBIA A RULLO - ROLLER BUCKLE	FERRO	IRON	8	3
A/8689/020	FIBBIA A RULLO - ROLLER BUCKLE	FERRO	IRON	8	3
A/8689/025	FIBBIA A RULLO - ROLLER BUCKLE	FERRO	IRON	8	3
A/8689/030	FIBBIA A RULLO - ROLLER BUCKLE	FERRO	IRON	8	3
A/8689/035	FIBBIA A RULLO - ROLLER BUCKLE	FERRO	IRON	8	3
A/8689/040	FIBBIA A RULLO - ROLLER BUCKLE	FERRO	IRON	8	3
A/8689/050	FIBBIA A RULLO - ROLLER BUCKLE	FERRO	IRON	8	3
A/8999/000	MOLLA A CALAMITA - MAGNETIC LOCK	OTTONE + FERRO	BRASS + IRON	5	2
A/9521/002	VITE PER REGISTRO MM 3,5 X 5 - SCREW	FERRO	IRON	9	2
A/9521/003	VITE PER REGISTRO MM 3,5 X 5 - SCREW	FERRO	IRON	9	2
A/9521/005	VITE PER REGISTRO 3 X 5 FEMMINA SENZA TAGLIO - SCREW FEMALE	FERRO	IRON	9	2
A/9700/025	MOSCHETTONE - DOG CLIP	ZAMA	ZINC ALLOY	12	10
A/9700/040	MOSCHETTONE - DOG CLIP	ZAMA	ZINC ALLOY	12	10
C					
C/1259/001	GEMELLO FILETTATO 3MA - 3MA THREADED STUD	OTTONE	SOLID BRASS	9	1
C/1433/000	MOLLA A CALAMITA - MAGNETIC LOCK	OTTONE + FERRO	BRASS + IRON	5	2
C/1828/000	OCCHIELLO A VITE - SCREW EYELET	OTTONE	SOLID BRASS	13	4
C/1829/000	OCCHIELLO A VITE - SCREW EYELET	OTTONE	SOLID BRASS	13	4
C/1852/025	SCORREVOLE - SLIDER WITH ADJUSTABLE BAR	FERRO	IRON	18	1
C/1852/040	SCORREVOLE - SLIDER WITH ADJUSTABLE BAR	FERRO	IRON	18	1
C/1852/050	SCORREVOLE - SLIDER WITH ADJUSTABLE BAR	FERRO	IRON	18	1
C/1906/020	MOSCHETTONE - DOG CLIP	ZAMA	ZINC ALLOY	12	13

ARTICOLO - ITEMS	DESCRIZIONE - DESCRIPTION	MATERIALE	MATERIAL	CAT	PG
C/1906/030	MOSCHETTONE - DOG CLIP	ZAMA	ZINC ALLOY	12	13
C/1907/020	MOSCHETTONE - DOG CLIP	ZAMA	ZINC ALLOY	12	14
C/1907/030	MOSCHETTONE - DOG CLIP	ZAMA	ZINC ALLOY	12	14
C/2318/000	TIRALAMPO CON CURSORE - ZIP PULLER WITH SLIDER	ZAMA	ZINC ALLOY	20	2
C/2343/050	FIBBIA DOPPIA - BUCKLE	ZAMA	ZINC ALLOY	8	13
C/2450/000	OCCHIELLO A PRESSIONE - PRESSURE EYELET	ZAMA	ZINC ALLOY	13	4
C/2451/000	OCCHIELLO A PRESSIONE - PRESSURE EYELET	ZAMA	ZINC ALLOY	13	4
C/2486/000	TIRALAMPO CON CURSORE - ZIP PULLER WITH SLIDER	ZAMA	ZINC ALLOY	20	1
C/2707/001	CHIUSURA CON GIRELLO - LOCK	ZAMA	ZINC ALLOY	6	8
C/2853/000	MOLLA A CALAMITA - MAGNETIC LOCK	OTTONE + FERRO	BRASS + IRON	5	1
C/2979/000	OCCHIELLO A PRESSIONE - PRESSURE EYELET	ZAMA	ZINC ALLOY	13	5
C/3046/000	OCCHIELLO A VITE - SCREW EYELET	OTTONE	SOLID BRASS	13	4
C/3050/015	FIBBIA DOPPIA - BUCKLE	ZAMA	ZINC ALLOY	8	7
C/3050/020	FIBBIA DOPPIA - BUCKLE	ZAMA	ZINC ALLOY	8	7
C/3050/025	FIBBIA DOPPIA - BUCKLE	ZAMA	ZINC ALLOY	8	7
C/3080/000	GEMELLO FILETTATO 3MA - 3MA THREADED STUD	OTTONE	SOLID BRASS	9	1
C/3081/000	GEMELLO FILETTATO 3MA - 3MA THREADED STUD	OTTONE	SOLID BRASS	9	1
C/3082/000	GEMELLO FILETTATO 3MA - 3MA THREADED STUD	OTTONE	SOLID BRASS	9	1
C/3083/000	GEMELLO FILETTATO 3MA - 3MA THREADED STUD	OTTONE	SOLID BRASS	9	1
C/3084/000	GEMELLO FILETTATO 3MA - 3MA THREADED STUD	OTTONE	SOLID BRASS	9	1
C/3097/008	ATTACCO - HANDLE HOLDER	OTTONE + FERRO	SOLID BRASS + IRON	7	1
C/3097/010	ATTACCO - HANDLE HOLDER	OTTONE + FERRO	SOLID BRASS + IRON	7	1
C/3118/020	MOSCHETTONE - DOG CLIP	ZAMA	ZINC ALLOY	12	4
C/3119/025	ANELLO 25X5 -SOLID RING	ZAMA	ZINC ALLOY	1	11
C/3279/020	MEZZA FIBBIA - BUCKLE	ZAMA	ZINC ALLOY	8	17
C/3279/025	MEZZA FIBBIA - BUCKLE	ZAMA	ZINC ALLOY	8	17
C/3400/000	MOLLA A CALAMITA - MAGNETIC LOCK	OTTONE + FERRO	BRASS + IRON	5	2
C/3647/000	GEMELLO FILETTATO 3MA - 3MA THREADED STUD	OTTONE	SOLID BRASS	9	1
C/3723/000	GEMELLO FILETTATO 3MA - 3MA THREADED STUD	OTTONE	SOLID BRASS	9	1
C/3725/016	FIBBIA DOPPIA - BUCKLE	ZAMA	ZINC ALLOY	8	7
C/3725/020	FIBBIA DOPPIA - BUCKLE	ZAMA	ZINC ALLOY	8	7

ARTICOLO - ITEMS	DESCRIZIONE - DESCRIPTION	MATERIALE	MATERIAL	CAT	PG
C/3725/025	FIBBIA DOPPIA - BUCKLE	ZAMA	ZINC ALLOY	8	7
C/3725/030	FIBBIA DOPPIA - BUCKLE	ZAMA	ZINC ALLOY	8	7
C/3813/000	OCCHIELLO A PRESSIONE - PRESSURE EYELET	ZAMA	ZINC ALLOY	13	4
C/3921/000	GEMELLO FILETTATO 3MA - 3MA THREADED STUD	OTTONE	SOLID BRASS	9	1
C/3979/000	CHIUSURA CON GIRELLO - LOCK	ZAMA	ZINC ALLOY	6	8
C/4081/000	GUARNIZIONE CON RIVETTO - STUD WITH RIVET	ZAMA	ZINC ALLOY	10	2
C/4208/022	ANELLO BRISE' - SPRING RING	ACCIAIO	STEEL	16	1
C/4208/025	ANELLO BRISE' - SPRING RING	ACCIAIO	STEEL	16	1
C/4208/030	ANELLO BRISE' - SPRING RING	ACCIAIO	STEEL	16	1
C/4210/000	FASCETTA - CLAMP	FERRO	IRON	19	1
C/4240/000	CHIUSURA CON GIRELLO - LOCK	ZAMA	ZINC ALLOY	6	7
C/4243/020	ANELLO A "D" - SOLID "D" RING	ZAMA	ZINC ALLOY	1	20
C/4243/025	ANELLO A "D" - SOLID "D" RING	ZAMA	ZINC ALLOY	1	20
C/4244/025	ANELLO - SOLID RING	ZAMA	ZINC ALLOY	1	17
C/4245/020	ANELLO - SOLID RING	ZAMA	ZINC ALLOY	1	17
C/4257/000	ATTACCO - HANDLE HOLDER	ZAMA	ZINC ALLOY	2	10
C/4271/016	FIBBIA DOPPIA - BUCKLE	ZAMA	ZINC ALLOY	8	7
C/4271/020	FIBBIA DOPPIA - BUCKLE	ZAMA	ZINC ALLOY	8	7
C/4271/025	FIBBIA DOPPIA - BUCKLE	ZAMA	ZINC ALLOY	8	7
C/4416/015	ANELLO A "D" - SOLID "D" RING	ZAMA	ZINC ALLOY	1	20
C/4467/016	ANELLO RETTANGOLARE - RECT.SOLID RING	ZAMA	ZINC ALLOY	1	18
C/4588/025	ANELLO 25X3,8 -SOLID RING	ZAMA	ZINC ALLOY	1	12
C/4589/020	ANELLO 20X4 -SOLID RING	ZAMA	ZINC ALLOY	1	12
C/4617/025	ANELLO RETTANGOLARE 25X20X4 - RECT.SOLID RING	ZAMA	ZINC ALLOY	1	15
C/4617/030	ANELLO RETTANGOLARE 30X20X5 - RECT.SOLID RING	ZAMA	ZINC ALLOY	1	15
C/4636/030	ANELLO 30X5,5 -SOLID RING	ZAMA	ZINC ALLOY	1	11
C/4636/035	ANELLO 35X6 -SOLID RING	ZAMA	ZINC ALLOY	1	11
C/4636/040	ANELLO 40X6,3 -SOLID RING	ZAMA	ZINC ALLOY	1	11
C/4636/050	ANELLO 50X6,2 -SOLID RING	ZAMA	ZINC ALLOY	1	11
C/4636/055	ANELLO 55X6,3 -SOLID RING	ZAMA	ZINC ALLOY	1	11
C/4668/015	<u>MEZZA FIBBIA - BUCKLE</u>	ZAMA	ZINC ALLOY	8	20

ARTICOLO - ITEMS	DESCRIZIONE - DESCRIPTION	MATERIALE	MATERIAL	CAT	PG
C/4668/020	MEZZA FIBBIA - BUCKLE	ZAMA	ZINC ALLOY	8	20
C/4668/025	MEZZA FIBBIA - BUCKLE	ZAMA	ZINC ALLOY	8	20
C/4668/030	MEZZA FIBBIA - BUCKLE	ZAMA	ZINC ALLOY	8	20
C/4668/040	MEZZA FIBBIA - BUCKLE	ZAMA	ZINC ALLOY	8	28
C/4767/000	BOCCIOLIO FILETTATO - TIP THRADED	ZAMA	ZINC ALLOY	2	11
C/4775/000	ATTACCO CON ALETTE - HANDLE HOLDER WITH PRONGS	ZAMA	ZINC ALLOY	2	8
C/4838/020	FIBBIA DOPPIA - BUCKLE	ZAMA	ZINC ALLOY	8	9
C/4838/025	FIBBIA DOPPIA - BUCKLE	ZAMA	ZINC ALLOY	8	9
C/4838/030	FIBBIA DOPPIA - BUCKLE	ZAMA	ZINC ALLOY	8	9
C/4851/015	MEZZA FIBBIA - BUCKLE	ZAMA	ZINC ALLOY	8	18
C/4851/020	MEZZA FIBBIA - BUCKLE	ZAMA	ZINC ALLOY	8	18
C/4851/025	MEZZA FIBBIA - BUCKLE	ZAMA	ZINC ALLOY	8	18
C/4934/000	OCCHIELLO - EYELET	FERRO	IRON	13	3
C/4935/000	OCCHIELLO - EYELET	OTTONE	IRON	13	3
C/5009/020	MEZZA FIBBIA - BUCKLE	ZAMA	ZINC ALLOY	8	15
C/5019/016	FIBBIA DOPPIA - BUCKLE	ZAMA	ZINC ALLOY	8	7
C/5019/020	FIBBIA DOPPIA - BUCKLE	ZAMA	ZINC ALLOY	8	7
C/5019/025	FIBBIA DOPPIA - BUCKLE	ZAMA	ZINC ALLOY	8	7
C/5019/030	FIBBIA DOPPIA - BUCKLE	ZAMA	ZINC ALLOY	8	7
C/5020/010	MEZZA FIBBIA - BUCKLE	ZAMA	ZINC ALLOY	8	18
C/5020/016	MEZZA FIBBIA - BUCKLE	ZAMA	ZINC ALLOY	8	18
C/5020/020	MEZZA FIBBIA - BUCKLE	ZAMA	ZINC ALLOY	8	18
C/5020/025	MEZZA FIBBIA - BUCKLE	ZAMA	ZINC ALLOY	8	18
C/5029/008	ATTACCO CON ALETTE - HANDLE HOLDER WITH PRONGS	ZAMA	ZINC ALLOY	2	8
C/5047/015	SCORREVOLE - SLIDER WITH FIXED BAR	ZAMA	ZINC ALLOY	18	4
C/5047/020	SCORREVOLE - SLIDER WITH FIXED BAR	ZAMA	ZINC ALLOY	18	4
C/5047/025	SCORREVOLE - SLIDER WITH FIXED BAR	ZAMA	ZINC ALLOY	18	4
C/5051/000	GUARNIZIONE CON RIVETTO - STUD WITH RIVET	ZAMA	ZINC ALLOY	10	2
C/5113/015	ANELLO FILO PIATTO - FLAT WIRE RING	ZAMA	ZINC ALLOY	1	13
C/5137/015	MEZZA FIBBIA - BUCKLE	ZAMA	ZINC ALLOY	8	15
C/5137/020	MEZZA FIBBIA - BUCKLE	ZAMA	ZINC ALLOY	8	15

ARTICOLO - ITEMS	DESCRIZIONE - DESCRIPTION	MATERIALE	MATERIAL	CAT	PG
C/5140/015	MOSCHETTONE - DOG CLIP	ZAMA	ZINC ALLOY	12	4
C/5140/020	MOSCHETTONE - DOG CLIP	ZAMA	ZINC ALLOY	12	4
C/5140/025	MOSCHETTONE - DOG CLIP	ZAMA	ZINC ALLOY	12	4
C/5153/030	PASSANTE - KEEPER	ZAMA	ZINC ALLOY	15	1
C/5153/035	PASSANTE - KEEPER	ZAMA	ZINC ALLOY	15	1
C/5153/040	PASSANTE - KEEPER	ZAMA	ZINC ALLOY	15	1
C/5159/001	GUARNIZIONE CON RIVETTO - STUD WITH RIVET	ZAMA	ZINC ALLOY	10	2
C/5163/000	PENDENTE - PULLER	ZAMA	ZINC ALLOY	20	5
C/5163/001	TIRALAMPO CON CURSORE - ZIP PULLER WITH SLIDER	ZAMA	ZINC ALLOY	20	1
C/5164/001	TIRALAMPO CON CURSORE - ZIP PULLER WITH SLIDER	ZAMA	ZINC ALLOY	20	1
C/5182/000	GUARNIZIONE CON RIVETTO - STUD WITH RIVET	ZAMA	ZINC ALLOY	10	2
C/5200/000	BOCCIOLIO FILETTATO - TIP THRADDDED	ZAMA	ZINC ALLOY	2	11
C/5224/000	CHIUSURA TIC TUC - LOCK	ZAMA	ZINC ALLOY	6	3
C/5225/020	MEZZA FIBBIA - BUCKLE	ZAMA	ZINC ALLOY	8	16
C/5225/030	MEZZA FIBBIA - BUCKLE	ZAMA	ZINC ALLOY	8	16
C/5225/035	MEZZA FIBBIA - BUCKLE	ZAMA	ZINC ALLOY	8	24
C/5247/001	TIRALAMPO CON CURSORE - ZIP PULLER WITH SLIDER	ZAMA	ZINC ALLOY	20	1
C/5298/016	FIBBIA DOPPIA - BUCKLE	ZAMA	ZINC ALLOY	8	9
C/5298/020	FIBBIA DOPPIA - BUCKLE	ZAMA	ZINC ALLOY	8	9
C/5298/025	FIBBIA DOPPIA - BUCKLE	ZAMA	ZINC ALLOY	8	9
C/5298/030	FIBBIA DOPPIA - BUCKLE	ZAMA	ZINC ALLOY	8	9
C/5298/035	FIBBIA DOPPIA - BUCKLE	ZAMA	ZINC ALLOY	8	9
C/5300/016	FIBBIA DOPPIA - BUCKLE	ZAMA	ZINC ALLOY	8	7
C/5300/020	FIBBIA DOPPIA - BUCKLE	ZAMA	ZINC ALLOY	8	7
C/5300/025	FIBBIA DOPPIA - BUCKLE	ZAMA	ZINC ALLOY	8	7
C/5300/030	FIBBIA DOPPIA - BUCKLE	ZAMA	ZINC ALLOY	8	7
C/5307/015	MEZZA FIBBIA - BUCKLE	ZAMA	ZINC ALLOY	8	19
C/5307/020	MEZZA FIBBIA - BUCKLE	ZAMA	ZINC ALLOY	8	19
C/5307/025	MEZZA FIBBIA - BUCKLE	ZAMA	ZINC ALLOY	8	19
C/5307/030	MEZZA FIBBIA - BUCKLE	ZAMA	ZINC ALLOY	8	19
C/5313/001	TIRALAMPO CON CURSORE - ZIP PULLER WITH SLIDER	ZAMA	ZINC ALLOY	20	1

ARTICOLO - ITEMS	DESCRIZIONE - DESCRIPTION	MATERIALE	MATERIAL	CAT	PG
C/5316/020	PASSANTE - KEEPER	ZAMA	ZINC ALLOY	15	1
C/5316/025	PASSANTE - KEEPER	ZAMA	ZINC ALLOY	15	1
C/5316/030	PASSANTE - KEEPER	ZAMA	ZINC ALLOY	15	1
C/5324/000	FASCETTA - CLAMP	FERRO	IRON	19	1
C/5337/000	ANELLO BRISE' - SPRING RING	ACCIAIO	STEEL	16	1
C/5371/001	TIRALAMPO CON CURSORE - ZIP PULLER WITH SLIDER	ZAMA	ZINC ALLOY	20	1
C/5400/020	CHIUSURA A PULSANTE - LOCK	ZAMA	ZINC ALLOY	6	13
C/5400/030	CHIUSURA A PULSANTE - LOCK	ZAMA	ZINC ALLOY	6	13
C/5400/040	CHIUSURA A PULSANTE - LOCK	ZAMA	ZINC ALLOY	6	13
C/5424/001	GEMELLO A PRESSIONE - STUD	OTTONE	SOLID BRASS	9	2
C/5434/020	ANELLO RETTANGOLARE - RECT.SOLID RING	ZAMA	ZINC ALLOY	2	1
C/5434/025	ANELLO RETTANGOLARE - RECT.SOLID RING	ZAMA	ZINC ALLOY	2	1
C/5434/030	ANELLO RETTANGOLARE - RECT.SOLID RING	ZAMA	ZINC ALLOY	2	1
C/5434/035	ANELLO RETTANGOLARE - RECT.SOLID RING	ZAMA	ZINC ALLOY	2	1
C/5434/040	ANELLO RETTANGOLARE - RECT.SOLID RING	ZAMA	ZINC ALLOY	2	1
C/5457/020	ANELLO RETTANGOLARE - RECT.SOLID RING	ZAMA	ZINC ALLOY	1	18
C/5457/025	ANELLO RETTANGOLARE - RECT.SOLID RING	ZAMA	ZINC ALLOY	1	18
C/5457/030	ANELLO RETTANGOLARE - RECT.SOLID RING	ZAMA	ZINC ALLOY	1	18
C/5457/035	ANELLO RETTANGOLARE - RECT.SOLID RING	ZAMA	ZINC ALLOY	1	18
C/5458/030	SCORREVOLE - SLIDER WITH FIXED BAR	ZAMA	ZINC ALLOY	18	4
C/5458/040	SCORREVOLE - SLIDER WITH FIXED BAR	ZAMA	ZINC ALLOY	18	4
C/5469/016	MEZZA FIBBIA - BUCKLE	ZAMA	ZINC ALLOY	8	18
C/5469/020	MEZZA FIBBIA - BUCKLE	ZAMA	ZINC ALLOY	8	18
C/5469/025	MEZZA FIBBIA - BUCKLE	ZAMA	ZINC ALLOY	8	18
C/5469/030	MEZZA FIBBIA - BUCKLE	ZAMA	ZINC ALLOY	8	18
C/5505/010	MOSCHETTONE - DOG CLIP	ZAMA	ZINC ALLOY	12	12
C/5512/030	MEZZA FIBBIA - BUCKLE	ZAMA	ZINC ALLOY	8	19
C/5513/016	ANELLO RETTANGOLARE - RECT.SOLID RING	ZAMA	ZINC ALLOY	1	18
C/5517/020	ANELLO RETTANGOLARE - RECT.SOLID RING	ZAMA	ZINC ALLOY	1	18
C/5520/015	ATTACCO - HANDLE HOLDER	ZAMA	ZINC ALLOY	2	1
C/5520/020	ATTACCO - HANDLE HOLDER	ZAMA	ZINC ALLOY	2	1

ARTICOLO - ITEMS	DESCRIZIONE - DESCRIPTION	MATERIALE	MATERIAL	CAT	PG
C/5520/025	ATTACCO - HANDLE HOLDER	ZAMA	ZINC ALLOY	2	1
C/5520/030	ATTACCO - HANDLE HOLDER	ZAMA	ZINC ALLOY	2	1
C/5521/030	MEZZA FIBBIA - BUCKLE	ZAMA	ZINC ALLOY	8	21
C/5523/030	MEZZA FIBBIA - BUCKLE	ZAMA	ZINC ALLOY	8	21
C/5525/030	MEZZA FIBBIA - BUCKLE	ZAMA	ZINC ALLOY	8	23
C/5551/030	FIBBIA CON CLIP A STRINGERE - CLIP-ON BUCKLE	ZAMA	ZINC ALLOY	8	31
C/5552/030	FIBBIA CON CLIP A STRINGERE - CLIP-ON BUCKLE	ZAMA	ZINC ALLOY	8	31
C/5555/030	FIBBIA CON CLIP A STRINGERE - CLIP-ON BUCKLE	ZAMA	ZINC ALLOY	8	31
C/5556/050	FIBBIA DOPPIA - BUCKLE	ZAMA	ZINC ALLOY	8	13
C/5573/010	ANELLO RETTANGOLARE - RECT.SOLID RING	ZAMA	ZINC ALLOY	1	18
C/5604/001	TIRALAMPO CON CURSORE - ZIP PULLER WITH SLIDER	ZAMA	ZINC ALLOY	20	1
C/5605/001	TIRALAMPO CON CURSORE - ZIP PULLER WITH SLIDER	ZAMA	ZINC ALLOY	20	1
C/5605/002	PENDENTE - PULLER	ZAMA	ZINC ALLOY	20	5
C/5609/020	MAGNETE NEODIMIO - NEODYMIUM MAGET	MAGNETE	MAGNET	5	3
C/5610/018	MAGNETE NEODIMIO - NEODYMIUM MAGET	MAGNETE	MAGNET	5	3
C/5614/020	ATTACCO - HANDLE HOLDER	ZAMA	ZINC ALLOY	2	1
C/5617/020	MAGNETE NEODIMIO - NEODYMIUM MAGET	MAGNETE	MAGNET	5	3
C/5636/015	ANELLO A "D" - SOLID "D" RING	ZAMA	ZINC ALLOY	1	20
C/5662/020	MAGNETE NEODIMIO - NEODYMIUM MAGET	MAGNETE	MAGNET	5	3
C/5670/010	MEZZA FIBBIA - BUCKLE	ZAMA	ZINC ALLOY	8	18
C/5670/015	MEZZA FIBBIA - BUCKLE	ZAMA	ZINC ALLOY	8	18
C/5672/015	ANELLO TRIANGOLARE - TRIANG.SOLID RING	ZAMA	ZINC ALLOY	1	20
C/5675/030	FIBBIA CON CLIP A STRINGERE - CLIP-ON BUCKLE	ZAMA	ZINC ALLOY	8	31
C/5676/016	ANELLO TRIANGOLARE - TRIANG.SOLID RING	ZAMA	ZINC ALLOY	1	20
C/5679/060	MEZZA FIBBIA - BUCKLE	ZAMA	ZINC ALLOY	8	29
C/5688/030	MAGNETE NEODIMIO - NEODYMIUM MAGET	MAGNETE	MAGNET	5	3
C/5712/000	OCCHIELLO A PRESSIONE - PRESSURE EYELET	ZAMA	ZINC ALLOY	13	5
C/5720/015	ANELLO QUADRATO - SQUARED SOLID RING	ZAMA	ZINC ALLOY	1	18
C/5723/028	ANELLO PIATTO - FLAT WIRE RING	ZAMA	ZINC ALLOY	1	13
C/5723/037	ANELLO PIATTO - FLAT WIRE RING	ZAMA	ZINC ALLOY	1	13
C/5723/040	ANELLO PIATTO - FLAT WIRE RING	ZAMA	ZINC ALLOY	1	13

ARTICOLO - ITEMS	DESCRIZIONE - DESCRIPTION	MATERIALE	MATERIAL	CAT	PG
C/5724/009	BORCHIA - STUD	FERRO	IRON	3	1
C/5724/012	BORCHIA - STUD	FERRO	IRON	3	1
C/5724/014	BORCHIA - STUD	FERRO	IRON	3	1
C/5727/000	GUARNIZIONE CON RIVETTO - STUD WITH RIVET	ZAMA	ZINC ALLOY	10	2
C/5738/020	MEZZA FIBBIA - BUCKLE	ZAMA	ZINC ALLOY	8	15
C/5738/025	MEZZA FIBBIA - BUCKLE	ZAMA	ZINC ALLOY	8	15
C/5738/030	MEZZA FIBBIA - BUCKLE	ZAMA	ZINC ALLOY	8	23
C/5751/060	FIBBIA DOPPIA - BUCKLE	ZAMA	ZINC ALLOY	8	13
C/5753/000	GEMELLO FILETTATO 3MA - 3MA THREADED STUD	OTTONE	SOLID BRASS	9	2
C/5754/020	FIBBIA DOPPIA - BUCKLE	ZAMA	ZINC ALLOY	8	14
C/5754/025	FIBBIA DOPPIA - BUCKLE	ZAMA	ZINC ALLOY	8	14
C/5769/010	FIBBIA DOPPIA - BUCKLE	ZAMA	ZINC ALLOY	8	8
C/5770/010	FIBBIA DOPPIA - BUCKLE	ZAMA	ZINC ALLOY	8	8
C/5772/010	FIBBIA DOPPIA - BUCKLE	ZAMA	ZINC ALLOY	8	8
C/5773/020	ANELLO RETTANGOLARE - RECT.SOLID RING	ZAMA	ZINC ALLOY	1	18
C/5779/040	MEZZA FIBBIA - BUCKLE	ZAMA	ZINC ALLOY	8	29
C/5781/030	ANELLO RETTANGOLARE - RECT.SOLID RING	ZAMA	ZINC ALLOY	1	18
C/5797/040	FIBBIA MILITARE - MILITARY BUCKLE	FERRO	IRON	8	36
C/5816/040	TERMINALE DENTATO A STRINGERE - END TIP W/TEETH	FERRO	IRON	8	36
C/5822/000	GEMELLO A PRESSIONE - STUD	OTTONE	SOLID BRASS	9	2
C/5830/060	MEZZA FIBBIA - BUCKLE	ZAMA	ZINC ALLOY	8	29
C/5832/020	FIBBIA DOPPIA - BUCKLE	ZAMA	ZINC ALLOY	8	8
C/5832/025	FIBBIA DOPPIA - BUCKLE	ZAMA	ZINC ALLOY	8	8
C/5834/030	FIBBIA CON CLIP A STRINGERE - CLIP-ON BUCKLE	ZAMA	ZINC ALLOY	8	31
C/5842/100	CATENA - CHAIN	FERRO	IRON	4	3
C/5843/000	MOSCHETTONE - DOG CLIP	ZAMA	ZINC ALLOY	12	5
C/5853/012	MEZZA FIBBIA - BUCKLE	ZAMA	ZINC ALLOY	8	15
C/5853/016	MEZZA FIBBIA - BUCKLE	ZAMA	ZINC ALLOY	8	15
C/5853/020	MEZZA FIBBIA - BUCKLE	ZAMA	ZINC ALLOY	8	15
C/5853/025	MEZZA FIBBIA - BUCKLE	ZAMA	ZINC ALLOY	8	15
C/5872/100	CATENA - CHAIN	OTTONE	SOLID BRASS	4	3

ARTICOLO - ITEMS	DESCRIZIONE - DESCRIPTION	MATERIALE	MATERIAL	CAT	PG
C/5876/014	ANELLO A "D" - SOLID "D" RING	ZAMA	ZINC ALLOY	1	20
C/5893/035	MEZZA FIBBIA - BUCKLE	ZAMA	ZINC ALLOY	8	28
C/5894/020	FIBBIA DOPPIA - BUCKLE	ZAMA	ZINC ALLOY	8	9
C/5895/007	GUARNIZIONE CON RIVETTO - STUD WITH RIVET	ZAMA	ZINC ALLOY	10	1
C/5895/014	GUARNIZIONE CON RIVETTO - STUD WITH RIVET	ZAMA	ZINC ALLOY	10	1
C/5895/016	GUARNIZIONE CON RIVETTO - STUD WITH RIVET	ZAMA	ZINC ALLOY	10	1
C/5898/020	SCORREVOLE - SLIDER WITH FIXED BAR	ZAMA	ZINC ALLOY	18	3
C/5898/025	SCORREVOLE - SLIDER WITH FIXED BAR	ZAMA	ZINC ALLOY	18	3
C/5898/030	SCORREVOLE - SLIDER WITH FIXED BAR	ZAMA	ZINC ALLOY	18	3
C/5898/040	SCORREVOLE - SLIDER WITH FIXED BAR	ZAMA	ZINC ALLOY	18	3
C/5898/050	SCORREVOLE - SLIDER WITH FIXED BAR	ZAMA	ZINC ALLOY	18	3
C/5928/035	ANELLO FILO PIATTO - FLAT WIRE RING	ZAMA	ZINC ALLOY	1	13
C/5930/025	FIBBIA DOPPIA - BUCKLE	ZAMA	ZINC ALLOY	8	10
C/5930/030	FIBBIA DOPPIA - BUCKLE	ZAMA	ZINC ALLOY	8	10
C/5930/035	FIBBIA DOPPIA - BUCKLE	ZAMA	ZINC ALLOY	8	10
C/5930/040	FIBBIA DOPPIA - BUCKLE	ZAMA	ZINC ALLOY	8	10
C/5930/050	FIBBIA DOPPIA - BUCKLE	ZAMA	ZINC ALLOY	8	10
C/5936/040	ANELLO RETTANGOLARE 41X10,9X5 - RECT.SOLID RING	ZAMA	ZINC ALLOY	1	15
C/5937/050	MEZZA FIBBIA - BUCKLE	ZAMA	ZINC ALLOY	8	29
C/5939/000	GUARNIZIONE CON RIVETTO - STUD WITH RIVET	ZAMA	ZINC ALLOY	10	2
C/5940/000	GUARNIZIONE CON RIVETTO - STUD WITH RIVET	ZAMA	ZINC ALLOY	10	2
C/5941/040	ANELLO 40X4,5 - SOLID RING	ZAMA	ZINC ALLOY	1	12
C/5941/060	ANELLO 60X5 - SOLID RING	ZAMA	ZINC ALLOY	1	12
C/5945/025	ANELLO 25X4,5 - SOLID RING	ZAMA	ZINC ALLOY	1	12
C/5946/015	ANELLO - SOLID RING	ZAMA	ZINC ALLOY	1	16
C/5946/020	ANELLO - SOLID RING	ZAMA	ZINC ALLOY	1	16
C/5946/025	ANELLO - SOLID RING	ZAMA	ZINC ALLOY	1	16
C/5947/020	ANELLO OVALE 20X15X5 - OVAL SOLID RING	ZAMA	ZINC ALLOY	1	16
C/5947/025	ANELLO OVALE 25X18,8X5 - OVAL SOLID RING	ZAMA	ZINC ALLOY	1	16
C/5947/030	ANELLO OVALE 30X22X5 - OVAL SOLID RING	ZAMA	ZINC ALLOY	1	16
C/5958/080	ANELLO 80X4,7 - SOLID RING	ZAMA	ZINC ALLOY	1	11

ARTICOLO - ITEMS	DESCRIZIONE - DESCRIPTION	MATERIALE	MATERIAL	CAT	PG
C/5963/025	MEZZA FIBBIA - BUCKLE	ZAMA	ZINC ALLOY	8	17
C/5963/030	MEZZA FIBBIA - BUCKLE	ZAMA	ZINC ALLOY	8	17
C/6012/016	FIBBIA DOPPIA - BUCKLE	ZAMA	ZINC ALLOY	8	14
C/6012/020	FIBBIA DOPPIA - BUCKLE	ZAMA	ZINC ALLOY	8	14
C/6012/025	FIBBIA DOPPIA - BUCKLE	ZAMA	ZINC ALLOY	8	14
C/6013/016	FIBBIA DOPPIA - BUCKLE	ZAMA	ZINC ALLOY	8	14
C/6013/020	FIBBIA DOPPIA - BUCKLE	ZAMA	ZINC ALLOY	8	14
C/6013/025	FIBBIA DOPPIA - BUCKLE	ZAMA	ZINC ALLOY	8	14
C/6013/030	FIBBIA DOPPIA - BUCKLE	ZAMA	ZINC ALLOY	8	14
C/6019/010	FIBBIA DOPPIA - BUCKLE	ZAMA	ZINC ALLOY	8	8
C/6019/015	FIBBIA DOPPIA - BUCKLE	ZAMA	ZINC ALLOY	8	8
C/6019/020	FIBBIA DOPPIA - BUCKLE	ZAMA	ZINC ALLOY	8	8
C/6032/015	ANELLO A "D" - SOLID "D" RING	ZAMA	ZINC ALLOY	1	20
C/6040/020	ANELLO A "D" 20X14X5,8 -"D" RING	ZAMA	ZINC ALLOY	1	21
C/6040/025	ANELLO A "D" 25X18X5,9 -"D" RING	ZAMA	ZINC ALLOY	1	21
C/6040/030	ANELLO A "D" 30X22X5,9 -"D" RING	ZAMA	ZINC ALLOY	1	21
C/6040/040	ANELLO A "D" 40X27X6 -"D" RING	ZAMA	ZINC ALLOY	1	21
C/6046/020	ANELLO RETTANGOLARE 20X13,8X4,5 - RECT.SOLID RING	ZAMA	ZINC ALLOY	1	14
C/6046/025	ANELLO RETTANGOLARE 25X13,8X4,7 - RECT.SOLID RING	ZAMA	ZINC ALLOY	1	14
C/6046/030	ANELLO RETTANGOLARE 30X15,8X5,9 - RECT.SOLID RING	ZAMA	ZINC ALLOY	1	14
C/6046/035	ANELLO RETTANGOLARE 35X16,8X6 - RECT.SOLID RING	ZAMA	ZINC ALLOY	1	14
C/6046/040	ANELLO RETTANGOLARE 40X15,7X5,9 - RECT.SOLID RING	ZAMA	ZINC ALLOY	1	14
C/6046/050	ANELLO RETTANGOLARE 50X16,4X5,9 - RECT.SOLID RING	ZAMA	ZINC ALLOY	1	14
C/6053/009	GUARNIZIONE CON RIVETTO - STUD WITH RIVET	ZAMA	ZINC ALLOY	10	1
C/6059/100	CATENA - CHAIN	ZAMA	ZINC ALLOY	4	4
C/6060/100	CATENA - CHAIN	ZAMA	ZINC ALLOY	4	4
C/6061/020	ATTACCO - HANDLE HOLDER	ZAMA	ZINC ALLOY	2	2
C/6061/025	ATTACCO - HANDLE HOLDER	ZAMA	ZINC ALLOY	2	2
C/6064/008	ANELLO A "D" - SOLID "D" RING	ZAMA	ZINC ALLOY	1	20
C/6069/040	ANELLO A "D" - SOLID "D" RING	ZAMA	ZINC ALLOY	1	21
C/6072/038	MEZZA FIBBIA - BUCKLE	ZAMA	ZINC ALLOY	8	17

ARTICOLO - ITEMS	DESCRIZIONE - DESCRIPTION	MATERIALE	MATERIAL	CAT	PG
C/6075/030	ANELLO OVALE 30X13X5,5 -OVAL SOLID RING	ZAMA	ZINC ALLOY	1	17
C/6075/040	ANELLO OVALE 40X13X5,9 -OVAL SOLID RING	ZAMA	ZINC ALLOY	1	17
C/6076/020	OCCHIELLO A PRESSIONE - PRESSURE EYELET	ZAMA	ZINC ALLOY	13	5
C/6079/009	GUARNIZIONE CON RIVETTO - STUD WITH RIVET	ZAMA	ZINC ALLOY	10	3
C/6079/012	GUARNIZIONE CON RIVETTO - STUD WITH RIVET	ZAMA	ZINC ALLOY	10	3
C/6079/016	GUARNIZIONE CON RIVETTO - STUD WITH RIVET	ZAMA	ZINC ALLOY	10	3
C/6082/009	GUARNIZIONE CON RIVETTO - STUD WITH RIVET	ZAMA	ZINC ALLOY	10	3
C/6082/012	GUARNIZIONE CON RIVETTO - STUD WITH RIVET	ZAMA	ZINC ALLOY	10	3
C/6082/014	GUARNIZIONE CON RIVETTO - STUD WITH RIVET	ZAMA	ZINC ALLOY	10	3
C/6084/000	GUARNIZIONE CON RIVETTO - STUD WITH RIVET	ZAMA	ZINC ALLOY	10	2
C/6085/015	GUARNIZIONE CON RIVETTO - STUD WITH RIVET	ZAMA	ZINC ALLOY	10	1
C/6090/040	ANELLO OVALE 40X14,5X7 -OVAL SOLID RING	ZAMA	ZINC ALLOY	1	17
C/6091/030	MEZZA FIBBIA - BUCKLE	ZAMA	ZINC ALLOY	8	17
C/6102/020	MEZZA FIBBIA - BUCKLE	ZAMA	ZINC ALLOY	8	19
C/6108/020	ANELLO A "D" 20X16,5X4,5 -"D" RING	ZAMA	ZINC ALLOY	1	21
C/6108/025	ANELLO A "D" 25X20X3,85 -"D" RING	ZAMA	ZINC ALLOY	1	21
C/6109/015	ANELLO RETTANGOLARE 15X13X4,2 - RECT.SOLID RING	ZAMA	ZINC ALLOY	1	15
C/6110/015	MEZZA FIBBIA - BUCKLE	ZAMA	ZINC ALLOY	8	15
C/6140/000	GEMELLO FILETTATO 3MA - 3MA THREADED STUD	OTTONE	SOLID BRASS	9	1
C/6141/014	ANELLO 14,6X3,2 -SOLID RING	ZAMA	ZINC ALLOY	1	12
C/6155/100	CATENA - CHAIN	ZAMA	ZINC ALLOY	4	4
C/6156/015	FIBBIA DOPPIA - BUCKLE	ZAMA	ZINC ALLOY	8	9
C/6157/007	GUARNIZIONE CON RIVETTO - STUD WITH RIVET	ZAMA	ZINC ALLOY	10	4
C/6157/012	GUARNIZIONE CON RIVETTO - STUD WITH RIVET	ZAMA	ZINC ALLOY	10	4
C/6157/014	GUARNIZIONE CON RIVETTO - STUD WITH RIVET	ZAMA	ZINC ALLOY	10	4
C/6158/015	ANELLO QUADRATO 15X15X5,8 - SQUARED RING	ZAMA	ZINC ALLOY	1	16
C/6158/020	ANELLO QUADRATO 20X20X6 - SQUARED RING	ZAMA	ZINC ALLOY	1	16
C/6158/025	ANELLO QUADRATO 25X25X5,9 - SQUARED RING	ZAMA	ZINC ALLOY	1	16
C/6160/001	TIRALAMPO CON CURSORE - ZIP PULLER WITH SLIDER	ZAMA	ZINC ALLOY	20	2
C/6161/038	ANELLO QUADRATO 38X38X7,8 - SQUARED RING	ZAMA	ZINC ALLOY	1	16
C/6163/100	CATENA - CHAIN	ZAMA	ZINC ALLOY	4	5

ARTICOLO - ITEMS	DESCRIZIONE - DESCRIPTION	MATERIALE	MATERIAL	CAT	PG
C/6164/100	CATENA - CHAIN	ZAMA	ZINC ALLOY	4	5
C/6165/100	CATENA - CHAIN	ZAMA	ZINC ALLOY	4	5
C/6175/028	AGGANCIATURA - LOCK	ZAMA	ZINC ALLOY	6	14
C/6178/040	ANELLO OVALE 40X18X7,9 - OVAL SOLID RING	ZAMA	ZINC ALLOY	1	17
C/6195/000	GUARNIZIONE CON RIVETTO - STUD WITH RIVET	ZAMA	ZINC ALLOY	10	2
C/6196/025	ANELLO RETTANGOLARE 25X20X6 - RECT.SOLID RING	ZAMA	ZINC ALLOY	1	16
C/6212/014	FIBBIA DOPPIA - BUCKLE	ZAMA	ZINC ALLOY	8	7
C/6212/020	FIBBIA DOPPIA - BUCKLE	ZAMA	ZINC ALLOY	8	7
C/6266/006	GUARNIZIONE CON RIVETTO - STUD WITH RIVET	ZAMA	ZINC ALLOY	10	3
C/6266/009	GUARNIZIONE CON RIVETTO - STUD WITH RIVET	ZAMA	ZINC ALLOY	10	3
C/6266/011	GUARNIZIONE CON RIVETTO - STUD WITH RIVET	ZAMA	ZINC ALLOY	10	3
C/6283/026	ANELLO BRISE' - SPRING RING	ACCIAIO	STEEL	16	1
C/6283/030	ANELLO BRISE' - SPRING RING	ACCIAIO	STEEL	16	1
C/6305/006	MAGNETE NEODIMIO - NEODYMIUM MAGET	MAGNETE	MAGNET	5	3
C/6305/010	MAGNETE NEODIMIO - NEODYMIUM MAGET	MAGNETE	MAGNET	5	3
C/6320/030	ATTACCO - HANDLE HOLDER	ZAMA	ZINC ALLOY	2	2
C/6320/040	ATTACCO - HANDLE HOLDER	ZAMA	ZINC ALLOY	2	2
C/6399/015	MEZZA FIBBIA - BUCKLE	ZAMA	ZINC ALLOY	8	20
C/6399/020	MEZZA FIBBIA - BUCKLE	ZAMA	ZINC ALLOY	8	20
C/6476/007	GUARNIZIONE CON RIVETTO - STUD WITH RIVET	ZAMA	ZINC ALLOY	10	4
C/6476/009	GUARNIZIONE CON RIVETTO - STUD WITH RIVET	ZAMA	ZINC ALLOY	10	4
C/6476/012	GUARNIZIONE CON RIVETTO - STUD WITH RIVET	ZAMA	ZINC ALLOY	10	4
C/6562/007	GUARNIZIONE CON RIVETTO - STUD WITH RIVET	ZAMA	ZINC ALLOY	10	3
C/6562/010	GUARNIZIONE CON RIVETTO - STUD WITH RIVET	ZAMA	ZINC ALLOY	10	3
C/6605/000	ANELLO BRISE' - SPRING RING	ACCIAIO	STEEL	16	1
C/6664/030	FIBBIA DOPPIA - BUCKLE	ZAMA	ZINC ALLOY	8	11
C/6664/040	FIBBIA DOPPIA - BUCKLE	ZAMA	ZINC ALLOY	8	11
C/6667/030	FIBBIA DOPPIA - BUCKLE	ZAMA	ZINC ALLOY	8	11
C/6700/020	ANELLO 20X5 -SOLID RING	ZAMA	ZINC ALLOY	1	12
C/6720/100	CATENA - CHAIN	FERRO + ZAMA	IRON +ZINC ALLOY	4	4
C/6727/000	CHIUSURA PER BRACCIALETTI - LOCK FOR BRACELET	ZAMA	ZINC ALLOY	6	17

ARTICOLO - ITEMS	DESCRIZIONE - DESCRIPTION	MATERIALE	MATERIAL	CAT	PG
C/6750/010	ANELLO A "D" - SOLID "D" RING	ZAMA	ZINC ALLOY	1	20
C/6756/000	MOLLA A CALAMITA - MAGNETIC LOCK	OTTONE + FERRO	BRASS + IRON	5	2
C/6757/000	MOLLA A CALAMITA - MAGNETIC LOCK	OTTONE + FERRO	BRASS + IRON	5	2
C/6760/000	GUARNIZIONE CON RIVETTO - STUD WITH RIVET	ZAMA	ZINC ALLOY	10	1
C/6797/022	BASE PER PORTACHIAVI - BASE FOR KEY HOLDER	ZAMA	ZINC ALLOY	16	2
C/6804/000	CHIUSURA CON GIRELLO - LOCK	ZAMA	ZINC ALLOY	6	9
C/6805/000	CHIUSURA CON GIRELLO - LOCK	ZAMA	ZINC ALLOY	6	9
C/6806/030	AGGANCIATURA - LOCK	ZAMA	ZINC ALLOY	6	14
C/6807/000	CHIUSURA A PULSANTE - LOCK	ZAMA	ZINC ALLOY	6	5
C/6839/007	PENDENTE - PULLER	ZAMA	ZINC ALLOY	20	5
D					
D/0102/000	LUCCHETTO - PADLOCK	ZAMA	ZINC ALLOY	6	12
D/0102/000	LUCCHETTO - PADLOCK	ZAMA	ZINC ALLOY	6	15
D/0103/000	LUCCHETTO - PADLOCK	ZAMA	ZINC ALLOY	6	15
D/0112/000	ATTACCO - HANDLE HOLDER	ZAMA	ZINC ALLOY	6	12
D/0113/070	PORTA DOLLARI - DOLLAR HOLDER	FERRO	IRON	16	4
D/0113/075	PORTA DOLLARI - DOLLAR HOLDER	FERRO	IRON	16	4
D/0122/015	MOSCHETTONE - DOG CLIP	ZAMA	ZINC ALLOY	12	12
D/0128/020	MOSCHETTONE - DOG CLIP	ZAMA	ZINC ALLOY	12	6
D/0135/012	MOSCHETTONE - DOG CLIP	ZAMA	ZINC ALLOY	12	6
D/0141/000	MOLLA A CALAMITA - MAGNETIC LOCK	OTTONE + FERRO	BRASS + IRON	5	1
D/0144/030	MEZZA FIBBIA - BUCKLE	ZAMA	ZINC ALLOY	8	23
D/0145/030	MEZZA FIBBIA - BUCKLE	ZAMA	ZINC ALLOY	8	23
D/0145/035	MEZZA FIBBIA - BUCKLE	ZAMA	ZINC ALLOY	8	24
D/0145/040	MEZZA FIBBIA - BUCKLE	ZAMA	ZINC ALLOY	8	27
D/0152/000	MOSCHETTONE - DOG CLIP	ZAMA	ZINC ALLOY	12	5
D/0152/001	MOSCHETTONE - DOG CLIP	ZAMA	ZINC ALLOY	12	5
D/0152/004	MOSCHETTONE - DOG CLIP	ZAMA	ZINC ALLOY	12	5
D/0158/000	MOSCHETTONE - DOG CLIP	ZAMA	ZINC ALLOY	12	12
D/0159/000	MOSCHETTONE - DOG CLIP	ZAMA	ZINC ALLOY	12	4
D/0164/015	ATTACCO CON SPINA - HANDLE HOLDER	ZAMA	ZINC ALLOY	2	4

ARTICOLO - ITEMS	DESCRIZIONE - DESCRIPTION	MATERIALE	MATERIAL	CAT	PG
D/0164/020	ATTACCO CON SPINA - HANDLE HOLDER	ZAMA	ZINC ALLOY	2	4
D/0169/035	MEZZA FIBBIA - BUCKLE	ZAMA	ZINC ALLOY	8	26
D/0183/000	CHIUSURA CON GIRELLO - LOCK	ZAMA	ZINC ALLOY	6	7
D/0187/022	BASE PER PORTACHIAVI - BASE FOR KEY HOLDER	ZAMA	ZINC ALLOY	16	2
D/0190/017	MOSCHETTONE - DOG CLIP	ZAMA	ZINC ALLOY	12	4
D/0192/000	MOSCHETTONE - DOG CLIP	ZAMA	ZINC ALLOY	12	2
D/0193/000	ATTACCO CON VITI - HANDLE HOLDER WITH SCREWS	ZAMA	ZINC ALLOY	2	10
D/0195/020	ATTACCO - HANDLE HOLDER	ZAMA	ZINC ALLOY	2	1
D/0198/015	MOSCHETTONE - DOG CLIP	ZAMA	ZINC ALLOY	12	3
D/0200/030	BASE PER PORTACHIAVI - BASE FOR KEY HOLDER	ZAMA	ZINC ALLOY	16	2
D/0200/035	BASE PER PORTACHIAVI - BASE FOR KEY HOLDER	ZAMA	ZINC ALLOY	16	2
D/0209/020	MOSCHETTONE - DOG CLIP	ZAMA	ZINC ALLOY	12	11
D/0209/025	MOSCHETTONE - DOG CLIP	ZAMA	ZINC ALLOY	12	11
D/0211/020	ATTACCO CON SPINA FILETTATA - HANDLE HOLDER	ZAMA	ZINC ALLOY	2	3
D/0211/025	ATTACCO CON SPINA FILETTATA - HANDLE HOLDER	ZAMA	ZINC ALLOY	2	3
D/0213/030	MEZZA FIBBIA - BUCKLE	ZAMA	ZINC ALLOY	8	23
D/0213/035	MEZZA FIBBIA - BUCKLE	ZAMA	ZINC ALLOY	8	24
D/0214/030	MEZZA FIBBIA - BUCKLE	ZAMA	ZINC ALLOY	8	23
D/0214/035	MEZZA FIBBIA - BUCKLE	ZAMA	ZINC ALLOY	8	24
D/0215/030	MEZZA FIBBIA - BUCKLE	ZAMA	ZINC ALLOY	8	21
D/0215/035	MEZZA FIBBIA - BUCKLE	ZAMA	ZINC ALLOY	8	26
D/0216/030	MEZZA FIBBIA - BUCKLE	ZAMA	ZINC ALLOY	8	21
D/0216/035	MEZZA FIBBIA - BUCKLE	ZAMA	ZINC ALLOY	8	24
D/0220/000	CHIUSURA CON GIRELLO - LOCK	ZAMA	ZINC ALLOY	6	8
D/0225/035	MEZZA FIBBIA - BUCKLE	ZAMA	ZINC ALLOY	8	26
D/0230/020	BASE PER PORTACHIAVI - BASE FOR KEY HOLDER	ZAMA	ZINC ALLOY	16	2
D/0236/000	CHIUSURA CON GIRELLO - LOCK	ZAMA	ZINC ALLOY	6	7
D/0240/030	ANELLO PIATTO - FLAT WIRE RING	ZAMA	ZINC ALLOY	1	13
D/0240/035	ANELLO PIATTO - FLAT WIRE RING	ZAMA	ZINC ALLOY	1	13
D/0242/025	MOSCHETTONE - DOG CLIP	ZAMA	ZINC ALLOY	12	10
D/0242/030	MOSCHETTONE - DOG CLIP	ZAMA	ZINC ALLOY	12	10

ARTICOLO - ITEMS	DESCRIZIONE - DESCRIPTION	MATERIALE	MATERIAL	CAT	PG
D/0242/040	MOSCHETTONE - DOG CLIP	ZAMA	ZINC ALLOY	12	10
D/0249/015	MOSCHETTONE - DOG CLIP	ZAMA	ZINC ALLOY	12	6
D/0249/020	MOSCHETTONE - DOG CLIP	ZAMA	ZINC ALLOY	12	6
D/0252/035	MEZZA FIBBIA - BUCKLE	ZAMA	ZINC ALLOY	8	26
D/0255/035	MEZZA FIBBIA - BUCKLE	ZAMA	ZINC ALLOY	8	24
D/0255/040	MEZZA FIBBIA - BUCKLE	ZAMA	ZINC ALLOY	8	28
D/0257/000	MOSCHETTONE - DOG CLIP	ZAMA	ZINC ALLOY	12	14
D/0258/025	MOSCHETTONE - DOG CLIP	ZAMA	ZINC ALLOY	12	14
D/0258/040	MOSCHETTONE - DOG CLIP	ZAMA	ZINC ALLOY	12	14
D/0259/000	CHIUSURA TIC TUC - LOCK	ZAMA	ZINC ALLOY	6	2
D/0279/000	MOSCHETTONE - DOG CLIP	ZAMA	ZINC ALLOY	12	2
D/0282/040	MEZZA FIBBIA - BUCKLE	ZAMA	ZINC ALLOY	8	28
D/0283/000	PORTACHIAVI - KEY CASE FITTING	FERRO + ZAMA	IRON + ZINC ALLOY	16	4
D/0284/000	PORTACHIAVI - KEY CASE FITTING	FERRO + ZAMA	IRON + ZINC ALLOY	16	4
D/0286/000	PORTACHIAVI - KEY CASE FITTING	FERRO + ZAMA	IRON + ZINC ALLOY	16	4
D/0288/040	MEZZA FIBBIA - BUCKLE	ZAMA	ZINC ALLOY	8	28
D/0298/000	MOSCHETTONE - DOG CLIP	ZAMA	ZINC ALLOY	12	16
D/0299/000	MOSCHETTONE - DOG CLIP	ZAMA	ZINC ALLOY	12	16
D/0308/035	FIBBIA CON CLIP A STRINGERE - CLIP-ON BUCKLE	ZAMA	ZINC ALLOY	8	33
D/0309/035	FIBBIA CON CLIP A STRINGERE - CLIP-ON BUCKLE	ZAMA	ZINC ALLOY	8	33
D/0311/035	FIBBIA CON CLIP A STRINGERE - CLIP-ON BUCKLE	ZAMA	ZINC ALLOY	8	33
D/0312/035	MEZZA FIBBIA - BUCKLE	ZAMA	ZINC ALLOY	8	25
D/0312/040	MEZZA FIBBIA - BUCKLE	ZAMA	ZINC ALLOY	8	25
D/0314/040	MEZZA FIBBIA - BUCKLE	ZAMA	ZINC ALLOY	8	27
D/0321/000	MOSCHETTONE - DOG CLIP	ZAMA	ZINC ALLOY	12	10
D/0323/004	PORTACHIAVI - KEY CASE FITTING	FERRO	IRON	16	3
D/0323/006	PORTACHIAVI - KEY CASE FITTING	FERRO	IRON	16	3
D/0326/025	ATTACCO - HANDLE HOLDER	ZAMA	ZINC ALLOY	2	6
D/0326/031	ATTACCO - HANDLE HOLDER	ZAMA	ZINC ALLOY	2	6
D/0326/037	ATTACCO - HANDLE HOLDER	ZAMA	ZINC ALLOY	2	6
D/0337/020	MOSCHETTONE - DOG CLIP	ZAMA	ZINC ALLOY	12	8

ARTICOLO - ITEMS	DESCRIZIONE - DESCRIPTION	MATERIALE	MATERIAL	CAT	PG
D/0337/025	MOSCHETTONE - DOG CLIP	ZAMA	ZINC ALLOY	12	8
D/0337/030	MOSCHETTONE - DOG CLIP	ZAMA	ZINC ALLOY	12	8
D/0337/040	MOSCHETTONE - DOG CLIP	ZAMA	ZINC ALLOY	12	8
D/0359/025	MOSCHETTONE - DOG CLIP	ZAMA	ZINC ALLOY	12	15
D/0359/031	MOSCHETTONE - DOG CLIP	ZAMA	ZINC ALLOY	12	15
D/0359/037	MOSCHETTONE - DOG CLIP	ZAMA	ZINC ALLOY	12	15
D/0361/000	CHIUSURA TIC TUC CON CHIAVE - LOCK WITH KEY	ZAMA	ZINC ALLOY	6	3
D/0364/000	CHIUSURA TIC TUC CON CHIAVE - LOCK WITH KEY	ZAMA	ZINC ALLOY	6	3
D/0366/025	MOSCHETTONE - DOG CLIP	ZAMA	ZINC ALLOY	12	14
D/0370/035	MEZZA FIBBIA - BUCKLE	ZAMA	ZINC ALLOY	8	25
D/0372/020	MOSCHETTONE - DOG CLIP	ZAMA	ZINC ALLOY	12	15
D/0372/030	MOSCHETTONE - DOG CLIP	ZAMA	ZINC ALLOY	12	16
D/0372/035	MOSCHETTONE - DOG CLIP	ZAMA	ZINC ALLOY	12	16
D/0372/040	MOSCHETTONE - DOG CLIP	ZAMA	ZINC ALLOY	12	16
D/0372/050	MOSCHETTONE - DOG CLIP	ZAMA	ZINC ALLOY	12	16
D/0372/060	MOSCHETTONE - DOG CLIP	ZAMA	ZINC ALLOY	12	16
D/0374/040	FIBBIA A RULLO - ROLLER BUCKLE	ZAMA	ZINC ALLOY	8	5
D/0379/000	MOSCHETTONE - DOG CLIP	ZAMA	ZINC ALLOY	12	15
D/0385/020	MOSCHETTONE - DOG CLIP	ZAMA	ZINC ALLOY	12	11
D/0385/025	MOSCHETTONE - DOG CLIP	ZAMA	ZINC ALLOY	12	11
D/0394/020	MOSCHETTONE - DOG CLIP	ZAMA	ZINC ALLOY	12	11
D/0394/025	MOSCHETTONE - DOG CLIP	ZAMA	ZINC ALLOY	12	11
D/0394/030	MOSCHETTONE - DOG CLIP	ZAMA	ZINC ALLOY	12	11
D/0398/000	CHIUSURA A CALAMITA - LOCK	OTTONE + FERRO	BRASS + IRON	6	8
D/0405/020	ATTACCO - HANDLE HOLDER	ZAMA	ZINC ALLOY	2	1
D/0405/025	ATTACCO - HANDLE HOLDER	ZAMA	ZINC ALLOY	2	1
D/0416/060	ANELLO PIATTO - FLAT WIRE RING	ZAMA	ZINC ALLOY	1	12
D/0419/015	MOSCHETTONE - DOG CLIP	ZAMA	ZINC ALLOY	12	9
D/0419/020	MOSCHETTONE - DOG CLIP	ZAMA	ZINC ALLOY	12	9
D/0419/025	MOSCHETTONE - DOG CLIP	ZAMA	ZINC ALLOY	12	9
D/0419/030	MOSCHETTONE - DOG CLIP	ZAMA	ZINC ALLOY	12	9

ARTICOLO - ITEMS	DESCRIZIONE - DESCRIPTION	MATERIALE	MATERIAL	CAT	PG
D/0427/020	MOSCHETTONE - DOG CLIP	ZAMA	ZINC ALLOY	12	11
D/0427/025	MOSCHETTONE - DOG CLIP	ZAMA	ZINC ALLOY	12	11
D/0430/010	FIBBIA A RULLO - ROLLER BUCKLE	ZAMA	ZINC ALLOY	8	6
D/0430/015	FIBBIA A RULLO - ROLLER BUCKLE	ZAMA	ZINC ALLOY	8	6
D/0430/020	FIBBIA A RULLO - ROLLER BUCKLE	ZAMA	ZINC ALLOY	8	6
D/0430/025	FIBBIA A RULLO - ROLLER BUCKLE	ZAMA	ZINC ALLOY	8	6
D/0430/030	FIBBIA A RULLO - ROLLER BUCKLE	ZAMA	ZINC ALLOY	8	6
D/0430/035	FIBBIA A RULLO - ROLLER BUCKLE	ZAMA	ZINC ALLOY	8	6
D/0430/040	FIBBIA A RULLO - ROLLER BUCKLE	ZAMA	ZINC ALLOY	8	6
D/0436/015	MOSCHETTONE - DOG CLIP	ZAMA	ZINC ALLOY	12	12
D/0436/020	MOSCHETTONE - DOG CLIP	ZAMA	ZINC ALLOY	12	12
D/0444/000	CHIUSURA TIC TUC - LOCK	ZAMA	ZINC ALLOY	6	2
D/0457/000	CHIUSURA CON GIRELLO - LOCK	ZAMA	ZINC ALLOY	6	8
D/0468/020	ANELLO FILO PIATTO - FLAT WIRE RING	ZAMA	ZINC ALLOY	1	13
D/0468/026	ANELLO FILO PIATTO - FLAT WIRE RING	ZAMA	ZINC ALLOY	1	13
D/0480/035	FIBBIA CON CLIP A STRINGERE - CLIP-ON BUCKLE	ZAMA	ZINC ALLOY	8	33
D/0482/035	FIBBIA CON CLIP A STRINGERE - CLIP-ON BUCKLE	ZAMA	ZINC ALLOY	8	33
D/0489/020	ATTACCO CON VITI - HANDLE HOLDER WITH SCREWS	ZAMA	ZINC ALLOY	2	7
D/0489/025	ATTACCO CON VITI - HANDLE HOLDER WITH SCREWS	ZAMA	ZINC ALLOY	2	7
D/0489/030	ATTACCO CON VITI - HANDLE HOLDER WITH SCREWS	ZAMA	ZINC ALLOY	2	7
D/0490/000	PENDENTE - PULLER	ZAMA	ZINC ALLOY	20	5
D/0490/001	TIRALAMPO CON CURSORE - ZIP PULLER WITH SLIDER	ZAMA	ZINC ALLOY	20	2
D/0512/017	MOSCHETTONE - DOG CLIP	ZAMA	ZINC ALLOY	12	7
D/0512/020	MOSCHETTONE - DOG CLIP	ZAMA	ZINC ALLOY	12	7
D/0512/025	MOSCHETTONE - DOG CLIP	ZAMA	ZINC ALLOY	12	7
D/0518/000	MOSCHETTONE - DOG CLIP	ZAMA	ZINC ALLOY	12	7
D/0519/000	GUARNIZIONE CON RIVETTO - STUD WITH RIVET	ZAMA	ZINC ALLOY	10	1
D/0519/001	GUARNIZIONE CON ALETTE - STUD WITH PRONGS	ZAMA	ZINC ALLOY	10	5
D/0520/000	MOSCHETTONE - DOG CLIP	ZAMA	ZINC ALLOY	12	4
D/0538/000	GUARNIZIONE CON ALETTE - STUD WITH PRONGS	ZAMA	ZINC ALLOY	10	5
D/0550/025	OCCHIELLO CON VITI - EYELET WITH SCREWS	ZAMA	ZINC ALLOY	13	5

ARTICOLO - ITEMS	DESCRIZIONE - DESCRIPTION	MATERIALE	MATERIAL	CAT	PG
D/0557/000	CHIUSURA CON GIRELLO - LOCK	ZAMA	ZINC ALLOY	6	7
D/0560/020	ATTACCO - HANDLE HOLDER	ZAMA	ZINC ALLOY	2	1
D/0560/024	ATTACCO - HANDLE HOLDER	ZAMA	ZINC ALLOY	2	1
D/0606/001	TIRALAMPO CON CURSORE - ZIP PULLER WITH SLIDER	ZAMA	ZINC ALLOY	20	4
D/0637/025	ATTACCO CON SPINA - HANDLE HOLDER	ZAMA	ZINC ALLOY	2	4
D/0664/020	MOSCHETTONE - DOG CLIP	ZAMA	ZINC ALLOY	12	7
D/0664/025	MOSCHETTONE - DOG CLIP	ZAMA	ZINC ALLOY	12	7
D/0666/000	MOLLA A CALAMITA - MAGNETIC LOCK	OTTONE + FERRO	BRASS + IRON	5	1
D/0669/000	MOSCHETTONE - DOG CLIP	ZAMA	ZINC ALLOY	12	8
D/0670/017	MOSCHETTONE - DOG CLIP	ZAMA	ZINC ALLOY	12	8
D/0670/020	MOSCHETTONE - DOG CLIP	ZAMA	ZINC ALLOY	12	8
D/0670/025	MOSCHETTONE - DOG CLIP	ZAMA	ZINC ALLOY	12	8
D/0671/000	ATTACCO CON VITI - HANDLE HOLDER WITH SCREWS	ZAMA	ZINC ALLOY	2	7
D/0672/000	MOSCHETTONE - DOG CLIP	ZAMA	ZINC ALLOY	12	7
D/0694/020	FIBBIA A RULLO - ROLLER BUCKLE	ZAMA	ZINC ALLOY	8	5
D/0694/025	FIBBIA A RULLO - ROLLER BUCKLE	ZAMA	ZINC ALLOY	8	5
D/0714/000	BOCCIOLO FILETTATO - TIP THRAPPED	ZAMA	ZINC ALLOY	2	11
D/0716/000	BOCCIOLO FILETTATO - TIP THRAPPED	ZAMA	ZINC ALLOY	2	11
D/0717/000	ATTACCO CON ALETTE - HANDLE HOLDER WITH PRONGS	ZAMA	ZINC ALLOY	2	8
D/0721/020	ANELLO RETTANGOLARE - RECT.SOLID RING	ZAMA	ZINC ALLOY	1	19
D/0721/025	ANELLO RETTANGOLARE - RECT.SOLID RING	ZAMA	ZINC ALLOY	1	19
D/0721/030	ANELLO RETTANGOLARE - RECT.SOLID RING	ZAMA	ZINC ALLOY	1	19
D/0721/040	ANELLO RETTANGOLARE - RECT.SOLID RING	ZAMA	ZINC ALLOY	1	19
D/0722/020	SCORREVOLE - SLIDER WITH FIXED BAR	ZAMA	ZINC ALLOY	18	4
D/0722/025	SCORREVOLE - SLIDER WITH FIXED BAR	ZAMA	ZINC ALLOY	18	4
D/0722/030	SCORREVOLE - SLIDER WITH FIXED BAR	ZAMA	ZINC ALLOY	18	4
D/0722/040	SCORREVOLE - SLIDER WITH FIXED BAR	ZAMA	ZINC ALLOY	18	4
D/0727/000	ANELLO FILO PIATTO - FLAT WIRE RING	ZAMA	ZINC ALLOY	1	13
D/0731/000	MOSCHETTONE - DOG CLIP	ZAMA	ZINC ALLOY	12	4
D/0736/025	FIBBIA DOPPIA - BUCKLE	ZAMA	ZINC ALLOY	8	9
D/0736/040	FIBBIA DOPPIA - BUCKLE	ZAMA	ZINC ALLOY	8	9

ARTICOLO - ITEMS	DESCRIZIONE - DESCRIPTION	MATERIALE	MATERIAL	CAT	PG
D/0739/000	MOSCHETTONE - DOG CLIP	ZAMA	ZINC ALLOY	12	2
D/0743/000	CHIUSURA CON LEVA - LOCK	ZAMA	ZINC ALLOY	6	10
D/0756/001	BOCCILO FILETTATO - TIP THRADDED	ZAMA	ZINC ALLOY	2	11
D/0765/000	CHIUSURA TIC TUC - LOCK	ZAMA	ZINC ALLOY	6	2
D/0775/010	MOSCHETTONE - DOG CLIP	ZAMA	ZINC ALLOY	12	2
D/0795/000	BOCCILO FILETTATO - TIP THRADDED	ZAMA	ZINC ALLOY	2	11
D/0804/000	CHIUSURA TIC TUC CON CHIAVE - LOCK WITH KEY	ZAMA	ZINC ALLOY	6	3
D/0805/000	CHIUSURA A PULSANTE - LOCK	ZAMA	ZINC ALLOY	6	4
D/0808/020	ATTACCO CON SPINA - HANDLE HOLDER	ZAMA	ZINC ALLOY	2	4
D/0826/000	GUARNIZIONE CON ALETTE - STUD WITH PRONGS	ZAMA	ZINC ALLOY	10	5
D/0827/000	GUARNIZIONE CON ALETTE - STUD WITH PRONGS	ZAMA	ZINC ALLOY	10	5
D/0848/012	MOSCHETTONE - DOG CLIP	ZAMA	ZINC ALLOY	12	1
D/0854/000	CHIUSURA CON GIRELLO - LOCK	ZAMA	ZINC ALLOY	6	6
D/0870/000	CHIUSURA TIC TUC - LOCK	ZAMA	ZINC ALLOY	6	2
D/0872/000	CHIUSURA TIC TUC - LOCK	ZAMA	ZINC ALLOY	6	2
D/0873/030	ANELLO 30X6 -SOLID RING	ZAMA	ZINC ALLOY	1	11
D/0873/032	ANELLO 32X6 -SOLID RING	ZAMA	ZINC ALLOY	1	11
D/0875/020	MOSCHETTONE - DOG CLIP	ZAMA	ZINC ALLOY	12	9
D/0875/025	MOSCHETTONE - DOG CLIP	ZAMA	ZINC ALLOY	12	9
D/0875/030	MOSCHETTONE - DOG CLIP	ZAMA	ZINC ALLOY	12	9
D/0875/040	MOSCHETTONE - DOG CLIP	ZAMA	ZINC ALLOY	12	9
D/0878/020	ATTACCO CON ALETTE - HANDLE HOLDER WITH PRONGS	ZAMA	ZINC ALLOY	2	10
D/0881/020	ANELLO RETTANGOLARE - RECT.SOLID RING	ZAMA	ZINC ALLOY	1	15
D/0883/000	MOSCHETTONE - DOG CLIP	ZAMA	ZINC ALLOY	12	15
D/0896/001	TIRALAMPO CON CURSORE - ZIP PULLER WITH SLIDER	ZAMA	ZINC ALLOY	20	2
D/0900/000	CHIUSURA TIC TUC CON CHIAVE - LOCK WITH KEY	ZAMA	ZINC ALLOY	6	3
D/0935/010	MOSCHETTONE - DOG CLIP	ZAMA	ZINC ALLOY	12	1
D/0936/000	PENDENTE - PULLER	ZAMA	ZINC ALLOY	20	5
D/0940/040	FIBBIA DOPPIA - BUCKLE	ZAMA	ZINC ALLOY	8	12
D/0944/030	FIBBIA DOPPIA - BUCKLE	ZAMA	ZINC ALLOY	8	12
D/0954/009	MOSCHETTONE - DOG CLIP	ZAMA	ZINC ALLOY	12	1

ARTICOLO - ITEMS	DESCRIZIONE - DESCRIPTION	MATERIALE	MATERIAL	CAT	PG
D/0983/015	FIBBIA A RULLO - ROLLER BUCKLE	ZAMA	ZINC ALLOY	8	5
D/0983/020	FIBBIA A RULLO - ROLLER BUCKLE	ZAMA	ZINC ALLOY	8	5
D/0989/030	FIBBIA DOPPIA - BUCKLE	ZAMA	ZINC ALLOY	8	12
D/0990/000	MOSCHETTONE - DOG CLIP	ZAMA	ZINC ALLOY	12	2
D/0991/000	MOSCHETTONE - DOG CLIP	ZAMA	ZINC ALLOY	12	2
D/0993/000	LUCCHETTO - PADLOCK	ZAMA	ZINC ALLOY	6	15
D/0994/035	MEZZA FIBBIA - BUCKLE	ZAMA	ZINC ALLOY	8	25
D/0994/040	MEZZA FIBBIA - BUCKLE	ZAMA	ZINC ALLOY	8	27
D/1003/000	BOCCIOLO FILETTATO - TIP THRADDLED	ZAMA	ZINC ALLOY	2	12
D/1008/030	MEZZA FIBBIA - BUCKLE	ZAMA	ZINC ALLOY	8	21
D/1033/017	MOSCHETTONE - DOG CLIP	ZAMA	ZINC ALLOY	12	3
D/1033/020	MOSCHETTONE - DOG CLIP	ZAMA	ZINC ALLOY	12	3
D/1045/000	GEMELLO FILETTATO 3MA - 3MA THREADED STUD	OTTONE	SOLID BRASS	9	2
D/1050/000	CHIUSURA CON GIRELLO - LOCK	ZAMA	ZINC ALLOY	6	8
D/1054/000	GEMELLO FILETTATO 3MA - 3MA THREADED STUD	OTTONE	SOLID BRASS	9	2
D/1055/000	PENDENTE - PULLER	ZAMA	ZINC ALLOY	20	4
D/1055/001	TIRALAMPO CON CURSORE - ZIP PULLER WITH SLIDER	ZAMA	ZINC ALLOY	20	4
D/1062/030	OCCHIELLO CON VITI - EYELET WITH SCREWS	ZAMA	ZINC ALLOY	13	5
D/1062/038	OCCHIELLO CON VITI - EYELET WITH SCREWS	ZAMA	ZINC ALLOY	13	5
D/1068/030	MEZZA FIBBIA - BUCKLE	ZAMA	ZINC ALLOY	8	27
D/1068/035	MEZZA FIBBIA - BUCKLE	ZAMA	ZINC ALLOY	8	27
D/1068/040	MEZZA FIBBIA - BUCKLE	ZAMA	ZINC ALLOY	8	27
D/1069/035	MEZZA FIBBIA - BUCKLE	ZAMA	ZINC ALLOY	8	26
D/1069/040	MEZZA FIBBIA - BUCKLE	ZAMA	ZINC ALLOY	8	27
D/1071/017	MOSCHETTONE - DOG CLIP	ZAMA	ZINC ALLOY	12	3
D/1074/000	MOSCHETTONE - DOG CLIP	ZAMA	ZINC ALLOY	12	3
D/1075/030	MEZZA FIBBIA - BUCKLE	ZAMA	ZINC ALLOY	8	26
D/1075/035	MEZZA FIBBIA - BUCKLE	ZAMA	ZINC ALLOY	8	26
D/1086/000	CHIUSURA CON GIRELLO - LOCK	ZAMA	ZINC ALLOY	6	7
D/1087/015	MOSCHETTONE - DOG CLIP	ZAMA	ZINC ALLOY	12	9
D/1087/020	MOSCHETTONE - DOG CLIP	ZAMA	ZINC ALLOY	12	9

ARTICOLO - ITEMS	DESCRIZIONE - DESCRIPTION	MATERIALE	MATERIAL	CAT	PG
D/1087/025	MOSCHETTONE - DOG CLIP	ZAMA	ZINC ALLOY	12	9
D/1087/030	MOSCHETTONE - DOG CLIP	ZAMA	ZINC ALLOY	12	9
D/1112/020	ATTACCO CON SPINA - HANDLE HOLDER	ZAMA	ZINC ALLOY	2	4
D/1112/025	ATTACCO CON SPINA - HANDLE HOLDER	ZAMA	ZINC ALLOY	2	4
D/1131/035	MEZZA FIBBIA - BUCKLE	ZAMA	ZINC ALLOY	8	25
D/1132/035	MEZZA FIBBIA - BUCKLE	ZAMA	ZINC ALLOY	8	25
D/1154/010	ANELLO A "D" - SOLID "D" RING	ZAMA	ZINC ALLOY	1	19
D/1154/015	ANELLO A "D" - SOLID "D" RING	ZAMA	ZINC ALLOY	1	19
D/1154/020	ANELLO A "D" - SOLID "D" RING	ZAMA	ZINC ALLOY	1	19
D/1154/025	ANELLO A "D" - SOLID "D" RING	ZAMA	ZINC ALLOY	1	19
D/1162/000	CHIUSURA CON GIRELLO - LOCK	ZAMA	ZINC ALLOY	6	6
D/1163/000	CHIUSURA CON GIRELLO - LOCK	ZAMA	ZINC ALLOY	6	9
D/1164/000	CHIUSURA CON LEVA - LOCK	ZAMA	ZINC ALLOY	6	10
D/1165/035	MEZZA FIBBIA - BUCKLE	ZAMA	ZINC ALLOY	8	25
D/1182/000	CHIUSURA CON GIRELLO - LOCK	ZAMA	ZINC ALLOY	6	9
D/1184/000	CHIUSURA - LOCK	ZAMA	ZINC ALLOY	6	10
D/1185/000	ATTACCO CON VITI - HANDLE HOLDER WITH SCREWS	ZAMA	ZINC ALLOY	2	7
D/1198/000	ANELLO FILO PIATTO - FLAT WIRE RING	ZAMA	ZINC ALLOY	1	13
D/1202/012	MOSCHETTONE - DOG CLIP	ZAMA	ZINC ALLOY	12	2
D/1206/010	CHIUSURA PER BRACCIALETTI - LOCK FOR BRACELET	ZAMA	ZINC ALLOY	6	16
D/1207/017	MOSCHETTONE - DOG CLIP	ZAMA	ZINC ALLOY	12	2
D/1208/010	CHIUSURA PER BRACCIALETTI - LOCK FOR BRACELET	ZAMA	ZINC ALLOY	6	16
D/1209/000	PENDENTE - PULLER	ZAMA	ZINC ALLOY	20	5
D/1209/001	TIRALAMPO CON CURSORE - ZIP PULLER WITH SLIDER	ZAMA	ZINC ALLOY	20	4
D/1212/000	MOSCHETTONE - DOG CLIP	ZAMA	ZINC ALLOY	12	4
D/1217/000	CHIUSURA CON BOCCHETTE - LOCK	ZAMA	ZINC ALLOY	6	11
D/1220/020	ATTACCO - HANDLE HOLDER	ZAMA	ZINC ALLOY	2	13
D/1221/020	MEZZA FIBBIA - BUCKLE	ZAMA	ZINC ALLOY	8	19
D/1221/030	MEZZA FIBBIA - BUCKLE	ZAMA	ZINC ALLOY	8	19
D/1222/000	CHIUSURA CON LEVA - LOCK	ZAMA	ZINC ALLOY	6	10
D/1227/003	CHIUSURA PER BRACCIALETTI - LOCK FOR BRACELET	ZAMA	ZINC ALLOY	6	16

ARTICOLO - ITEMS	DESCRIZIONE - DESCRIPTION	MATERIALE	MATERIAL	CAT	PG
D/1227/004	CHIUSURA PER BRACCIALETTI - LOCK FOR BRACELET	ZAMA	ZINC ALLOY	6	16
D/1227/005	CHIUSURA PER BRACCIALETTI - LOCK FOR BRACELET	ZAMA	ZINC ALLOY	6	16
D/1233/000	CHIUSURA - LOCK	ZAMA	ZINC ALLOY	6	9
D/1239/000	CHIUSURA CON GIRELLO - LOCK	ZAMA	ZINC ALLOY	6	6
D/1249/000	MOSCHETTONE - DOG CLIP	ZAMA	ZINC ALLOY	12	13
D/1250/000	ATTACCO CON ALETTE - HANDLE HOLDER WITH PRONGS	ZAMA	ZINC ALLOY	2	8
D/1252/020	ATTACCO - HANDLE HOLDER	ZAMA	ZINC ALLOY	2	10
D/1253/000	ATTACCO CON ALETTE - HANDLE HOLDER WITH PRONGS	ZAMA	ZINC ALLOY	2	8
D/1254/005	ATTACCO CON SPINA FILETTATA - HANDLE HOLDER	ZAMA	ZINC ALLOY	2	5
D/1258/000	PENDENTE - PULLER	ZAMA	ZINC ALLOY	20	4
D/1259/020	ATTACCO - HANDLE HOLDER	ZAMA	ZINC ALLOY	2	13
D/1263/015	FIBBIA A RULLO - ROLLER BUCKLE	ZAMA	ZINC ALLOY	8	6
D/1263/020	FIBBIA A RULLO - ROLLER BUCKLE	ZAMA	ZINC ALLOY	8	6
D/1263/025	FIBBIA A RULLO - ROLLER BUCKLE	ZAMA	ZINC ALLOY	8	6
D/1266/020	ATTACCO - HANDLE HOLDER	ZAMA	ZINC ALLOY	2	2
D/1268/015	MEZZA FIBBIA - BUCKLE	ZAMA	ZINC ALLOY	8	16
D/1268/020	MEZZA FIBBIA - BUCKLE	ZAMA	ZINC ALLOY	8	16
D/1268/025	MEZZA FIBBIA - BUCKLE	ZAMA	ZINC ALLOY	8	16
D/1269/010	FIBBIA DOPPIA - BUCKLE	ZAMA	ZINC ALLOY	8	8
D/1270/015	MEZZA FIBBIA - BUCKLE	ZAMA	ZINC ALLOY	8	16
D/1271/020	MEZZA FIBBIA - BUCKLE	ZAMA	ZINC ALLOY	8	16
D/1273/000	ATTACCO CON ALETTE - HANDLE HOLDER WITH PRONGS	ZAMA	ZINC ALLOY	2	8
D/1274/014	CHIUSURA PER BRACCIALETTI - LOCK FOR BRACELET	ACCIAIO	STEEL	6	16
D/1277/010	CHIUSURA PER BRACCIALETTI - LOCK FOR BRACELET	ACCIAIO	STEEL	6	16
D/1278/015	ATTACCO CON SPINA FILETTATA - HANDLE HOLDER	ZAMA	ZINC ALLOY	2	5
D/1278/020	ATTACCO CON SPINA FILETTATA - HANDLE HOLDER	ZAMA	ZINC ALLOY	2	5
D/1278/025	ATTACCO CON SPINA FILETTATA - HANDLE HOLDER	ZAMA	ZINC ALLOY	2	5
D/1279/000	PENDENTE - PULLER	ZAMA	ZINC ALLOY	20	4
D/1280/017	OCCHIELLO CON VITI - EYELET WITH SCREWS	ZAMA	ZINC ALLOY	13	5
D/1282/100	CATENA - CHAIN	ZAMA	ZINC ALLOY	4	5
D/1283/020	MOSCHETTONE - DOG CLIP	ZAMA	ZINC ALLOY	12	5

ARTICOLO - ITEMS	DESCRIZIONE - DESCRIPTION	MATERIALE	MATERIAL	CAT	PG
D/1283/025	MOSCHETTONE - DOG CLIP	ZAMA	ZINC ALLOY	12	5
D/1284/000	CHIUSURA CON CHIAVE - LOCK WITH KEY	ZAMA	ZINC ALLOY	6	4
D/1293/008	FERMA CURSORE - STOP SLIDER	OTTONE	SOLID BRASS	20	6
D/1295/000	CHIUSURA CON GIRELLO - LOCK	ZAMA	ZINC ALLOY	6	7
D/1300/000	MOLLA A CALAMITA - MAGNETIC LOCK	OTTONE + FERRO	BRASS + IRON	5	1
D/1301/005	CURSORE - SLIDER	ZAMA	ZINC ALLOY	20	6
D/1301/008	CURSORE - SLIDER	ZAMA	ZINC ALLOY	20	6
D/1302/100	CERNIERA LAMPO MM 5 - MM 5 ZIPPER	COTONE + OTTONE	COTTON + SOLID BRASS	20	7
D/1303/100	CERNIERA LAMPO MM 8 - MM 8 ZIPPER	COTONE + OTTONE	COTTON + SOLID BRASS	20	7
D/1304/000	CHIUSURA TIC TUC - LOCK	ZAMA	ZINC ALLOY	6	4
D/1307/030	FIBBIA CON CLIP A STRINGERE - CLIP-ON BUCKLE	ZAMA	ZINC ALLOY	8	30
D/1308/030	FIBBIA CON CLIP A STRINGERE - CLIP-ON BUCKLE	ZAMA	ZINC ALLOY	8	32
D/1309/030	FIBBIA CON CLIP A STRINGERE - CLIP-ON BUCKLE	ZAMA	ZINC ALLOY	8	32
D/1310/030	FIBBIA CON CLIP A STRINGERE - CLIP-ON BUCKLE	ZAMA	ZINC ALLOY	8	32
D/1311/030	FIBBIA CON CLIP A STRINGERE - CLIP-ON BUCKLE	ZAMA	ZINC ALLOY	8	32
D/1312/030	FIBBIA CON CLIP A STRINGERE - CLIP-ON BUCKLE	ZAMA	ZINC ALLOY	8	32
D/1317/000	CHIUSURA A PULSANTE - LOCK	ZAMA	ZINC ALLOY	6	5
D/1318/000	CHIUSURA CON CHIAVE - LOCK WITH KEY	ZAMA	ZINC ALLOY	6	4
D/1320/004	CHIUSURA PER BRACCIALETTI - LOCK FOR BRACELET	ZAMA	ZINC ALLOY	6	17
D/1322/000	CHIUSURA TIC TUC - LOCK	ZAMA	ZINC ALLOY	6	4
D/1324/040	FIBBIA CON CLIP A STRINGERE - CLIP-ON BUCKLE	ZAMA	ZINC ALLOY	8	35
D/1325/040	FIBBIA CON CLIP A STRINGERE - CLIP-ON BUCKLE	ZAMA	ZINC ALLOY	8	35
D/1326/040	FIBBIA CON CLIP A STRINGERE - CLIP-ON BUCKLE	ZAMA	ZINC ALLOY	8	35
D/1329/000	CHIUSURA CON BOCCHETTE - LOCK	ZAMA	ZINC ALLOY	6	12
D/1343/020	FIBBIA CON CLIP A STRINGERE - CLIP-ON BUCKLE	ZAMA	ZINC ALLOY	8	30
D/1344/020	FIBBIA CON CLIP A STRINGERE - CLIP-ON BUCKLE	ZAMA	ZINC ALLOY	8	30
D/1347/025	MOSCHETTONE - DOG CLIP	ZAMA	ZINC ALLOY	12	12
D/1348/040	ANELLO RETTANGOLARE 40X20,9X4 - RECT.SOLID RING	ZAMA	ZINC ALLOY	1	15
D/1353/020	ATTACCO CON VITI - HANDLE HOLDER WITH SCREWS	ZAMA	ZINC ALLOY	2	9
D/1359/000	ATTACCO CON VITI - HANDLE HOLDER WITH SCREWS	ZAMA	ZINC ALLOY	2	9
D/1360/000	MOSCHETTONE - DOG CLIP	ZAMA	ZINC ALLOY	12	3

ARTICOLO - ITEMS	DESCRIZIONE - DESCRIPTION	MATERIALE	MATERIAL	CAT	PG
D/1364/000	MOSCHETTONE - DOG CLIP	ZAMA	ZINC ALLOY	12	3
D/1365/010	MOSCHETTONE - DOG CLIP	ZAMA	ZINC ALLOY	12	6
D/1366/000	CHIUSURA A PULSANTE - LOCK	ZAMA	ZINC ALLOY	6	5
D/1367/004	CHIUSURA PER BRACCIALETTI - LOCK FOR BRACELET	ZAMA	ZINC ALLOY	6	18
D/1368/004	CHIUSURA PER BRACCIALETTI - LOCK FOR BRACELET	ZAMA	ZINC ALLOY	6	17
D/1369/004	CHIUSURA PER BRACCIALETTI - LOCK FOR BRACELET	ZAMA	ZINC ALLOY	6	17
D/1370/006	CHIUSURA PER BRACCIALETTI - LOCK FOR BRACELET	ZAMA	ZINC ALLOY	6	17
D/1373/000	CHIUSURA TIC TUC - LOCK	ZAMA	ZINC ALLOY	6	2
D/1374/000	PENDENTE - PULLER	ZAMA	ZINC ALLOY	20	3
D/1375/000	CHIUSURA CON LEVA - LOCK	ZAMA	ZINC ALLOY	6	10
D/1376/000	CHIUSURA A PULSANTE - LOCK	ZAMA	ZINC ALLOY	6	5
D/1377/010	MOSCHETTONE - DOG CLIP	ZAMA	ZINC ALLOY	12	6
D/1377/016	MOSCHETTONE - DOG CLIP	ZAMA	ZINC ALLOY	12	6
D/1377/020	MOSCHETTONE - DOG CLIP	ZAMA	ZINC ALLOY	12	6
D/1378/000	CHIUSURA CON BOCCHETTE - LOCK	ZAMA	ZINC ALLOY	6	12
D/1379/020	ATTACCO CON VITI - HANDLE HOLDER WITH SCREWS	ZAMA	ZINC ALLOY	2	9
D/1380/010	ATTACCO CON SPINA FILETTATA - HANDLE HOLDER	ZAMA	ZINC ALLOY	2	5
D/1381/020	CHIUSURA A PULSANTE - LOCK	PLASTICA + ZAMA	PLASTIC + ZINC ALLOY	6	13
D/1381/025	CHIUSURA A PULSANTE - LOCK	PLASTICA + ZAMA	PLASTIC + ZINC ALLOY	6	13
D/1385/005	FERMA CURSORE - STOP SLIDER	OTTONE	SOLID BRASS	20	6
D/1386/005	FERMA CURSORE - STOP SLIDER	OTTONE	SOLID BRASS	20	6
D/1391/020	ATTACCO CON SPINA FILETTATA - HANDLE HOLDER	ZAMA	ZINC ALLOY	2	5
D/1398/020	FIBBIA CON CLIP A STRINGERE - CLIP-ON BUCKLE	ZAMA	ZINC ALLOY	8	30
D/1399/000	CHIUSURA CON BOCCHETTE - LOCK	ZAMA	ZINC ALLOY	6	11
D/1403/018	ATTACCO CON VITI - HANDLE HOLDER WITH SCREWS	ZAMA	ZINC ALLOY	2	9
D/1406/000	BOCCIOLO FILETTATO - TIP THRADDLED	ZAMA	ZINC ALLOY	2	12
D/1413/000	CHIUSURA TIC TUC CON CHIAVE - LOCK WITH KEY	ZAMA	ZINC ALLOY	6	4
D/1416/100	CATENA - CHAIN	OTTONE	SOLID BRASS	4	3
D/1418/035	FIBBIA CON CLIP A STRINGERE - CLIP-ON BUCKLE	ZAMA	ZINC ALLOY	8	34
D/1424/000	CHIUSURA A PULSANTE - LOCK	ZAMA	ZINC ALLOY	6	5
D/1430/035	FIBBIA CON CLIP A STRINGERE - CLIP-ON BUCKLE	ZAMA	ZINC ALLOY	8	34

ARTICOLO - ITEMS	DESCRIZIONE - DESCRIPTION	MATERIALE	MATERIAL	CAT	PG
D/1435/015	ATTACCO - HANDLE HOLDER	ZAMA	ZINC ALLOY	2	1
D/1441/035	FIBBIA CON CLIP A STRINGERE - CLIP-ON BUCKLE	ZAMA	ZINC ALLOY	8	34
D/1442/035	FIBBIA CON CLIP A STRINGERE - CLIP-ON BUCKLE	ZAMA	ZINC ALLOY	8	34
D/1443/035	FIBBIA CON CLIP A STRINGERE - CLIP-ON BUCKLE	ZAMA	ZINC ALLOY	8	34
D/1444/005	BOCCILOLO - TIP	ZAMA	ZINC ALLOY	2	12
D/1452/000	PENDENTE - PULLER	ZAMA	ZINC ALLOY	20	3
D/1452/001	TIRALAMPO CON CURSORE - ZIP PULLER WITH SLIDER	ZAMA	ZINC ALLOY	20	3
D/1453/000	PENDENTE - PULLER	ZAMA	ZINC ALLOY	20	3
D/1453/001	TIRALAMPO CON CURSORE - ZIP PULLER WITH SLIDER	ZAMA	ZINC ALLOY	20	3
D/1454/000	MOSCHETTONE - DOG CLIP	ZAMA	ZINC ALLOY	12	2
D/1455/000	PENDENTE - PULLER	ZAMA	ZINC ALLOY	20	3
D/1455/001	TIRALAMPO CON CURSORE - ZIP PULLER WITH SLIDER	ZAMA	ZINC ALLOY	20	3
D/1456/009	PENDENTE - PULLER	ZAMA	ZINC ALLOY	20	5
D/1457/000	PENDENTE - PULLER	ZAMA	ZINC ALLOY	20	3
D/1458/000	PENDENTE - PULLER	ZAMA	ZINC ALLOY	20	3
D/1460/020	ATTACCO CON VITI - HANDLE HOLDER WITH SCREWS	ZAMA	ZINC ALLOY	2	10
D/1474/020	ATTACCO - HANDLE HOLDER	ZAMA	ZINC ALLOY	2	10
D/1476/000	ATTACCO CON VITI - HANDLE HOLDER WITH SCREWS	ZAMA	ZINC ALLOY	2	10
E					
E/1330/020	FIBBIA A RULLO - ROLLER BUCKLE	FERRO	IRON	8	4
E/1330/025	FIBBIA A RULLO - ROLLER BUCKLE	FERRO	IRON	8	4
E/1379/020	SCORREVOLE - SLIDER WITH ADJUSTABLE BAR	FERRO	IRON	18	2
E/1379/022	SCORREVOLE - SLIDER WITH ADJUSTABLE BAR	FERRO	IRON	18	2
E/1379/025	SCORREVOLE - SLIDER WITH ADJUSTABLE BAR	FERRO	IRON	18	2
E/1379/030	SCORREVOLE - SLIDER WITH ADJUSTABLE BAR	FERRO	IRON	18	2
E/1379/035	SCORREVOLE - SLIDER WITH ADJUSTABLE BAR	FERRO	IRON	18	2
E/1379/040	SCORREVOLE - SLIDER WITH ADJUSTABLE BAR	FERRO	IRON	18	2
E/2074/040	FIBBIA A RULLO - ROLLER BUCKLE	FERRO	IRON	8	1
E/3673/000	TIRALAMPO CON CURSORE - ZIP PULLER WITH SLIDER	FERRO + ZAMA	IRON + ZINC ALLOY	20	2
E/3779/100	CATENA - CHAIN	OTTONE	SOLID BRASS	4	3
E/3937/000	CURSORE - SLIDER	ZAMA	ZINC ALLOY	20	2

ARTICOLO - ITEMS	DESCRIZIONE - DESCRIPTION	MATERIALE	MATERIAL	CAT	PG
E/5808/000	GEMELLO FILETTATO 3MA - 3MA THREADED STUD	OTTONE	SOLID BRASS	9	1
F					
F/0010/001	ANELLO 8X1,2 -RING	FERRO	IRON	1	1
F/0020/001	ANELLO 5X1,5 -RING	FERRO	IRON	1	1
F/0022/001	ANELLO 6X1,5 -RING	FERRO	IRON	1	1
F/0026/001	ANELLO 8X1,5 -RING	FERRO	IRON	1	1
F/0038/001	ANELLO 7X2 -RING	FERRO	IRON	1	1
F/0040/001	ANELLO 8X2 -RING	FERRO	IRON	1	1
F/0044/001	ANELLO 10X2 -RING	FERRO	IRON	1	1
F/0048/001	ANELLO 12X2 -RING	FERRO	IRON	1	1
F/0052/001	ANELLO 15X2 -RING	FERRO	IRON	1	1
F/0060/001	ANELLO 12X2,5 -RING	FERRO	IRON	1	1
F/0064/001	ANELLO 15X2,5 -RING	FERRO	IRON	1	1
F/0068/001	ANELLO 18X2,5 -RING	FERRO	IRON	1	1
F/0070/001	ANELLO 20X2,5 -RING	FERRO	IRON	1	1
F/0090/001	ANELLO 20X3 -RING	FERRO	IRON	1	1
F/0092/001	ANELLO 22X3 -RING	FERRO	IRON	1	1
F/0094/001	ANELLO 25X3 -RING	FERRO	IRON	1	1
F/0112/001	ANELLO 20X4 -RING	FERRO	IRON	1	1
F/0114/001	ANELLO 22X4 -RING	FERRO	IRON	1	1
F/0118/001	ANELLO 25X4 -RING	FERRO	IRON	1	2
F/0120/001	ANELLO 30X4 -RING	FERRO	IRON	1	2
F/0124/001	ANELLO 35X4 -RING	FERRO	IRON	1	2
F/0126/001	ANELLO 28X5 -RING	FERRO	IRON	1	2
F/0128/001	ANELLO 30X5 -RING	FERRO	IRON	1	2
F/0130/001	ANELLO 35X5 -RING	FERRO	IRON	1	2
F/0131/001	ANELLO 40X5 -RING	FERRO	IRON	1	2
F/0140/004	ANELLO 40X6 - RING	FERRO	IRON	1	2
F/0142/004	ANELLO 45X7 -RING	FERRO	IRON	1	2
F/0210/001	ANELLO A "D" 8X6X2 -"D" RING	FERRO	IRON	1	3
F/0214/001	ANELLO A "D" 10X10X2 -"D" RING	FERRO	IRON	1	3

ARTICOLO - ITEMS	DESCRIZIONE - DESCRIPTION	MATERIALE	MATERIAL	CAT	PG
F/0216/001	ANELLO A "D" 12X10X2 -"D" RING	FERRO	IRON	1	3
F/0228/001	ANELLO A "D" 14X12X2,2 -"D" RING	FERRO	IRON	1	3
F/0234/001	ANELLO A "D" 16X14X2,4 -"D" RING	FERRO	IRON	1	3
F/0236/001	ANELLO A "D" 16X14X4 -"D" RING	FERRO	IRON	1	3
F/0242/001	ANELLO A "D" 18X14X2,5 -"D" RING	FERRO	IRON	1	3
F/0244/001	ANELLO A "D" 20X16X2,5 -"D" RING	FERRO	IRON	1	3
F/0246/001	ANELLO A "D" 25X20X2,5 -"D" RING	FERRO	IRON	1	3
F/0254/001	ANELLO A "D" 22X20X2,8 -"D" RING	FERRO	IRON	1	3
F/0260/001	ANELLO A "D" 25X20X3 -"D" RING	FERRO	IRON	1	3
F/0261/001	ANELLO A "D" 25X20X5 -"D" RING	FERRO	IRON	1	4
F/0264/001	ANELLO A "D" 30X25X3 -"D" RING	FERRO	IRON	1	4
F/0274/001	ANELLO A "D" 30X25X3,5 -"D" RING	FERRO	IRON	1	4
F/0278/001	ANELLO A "D" 20X16X4 -"D" RING	FERRO	IRON	1	3
F/0283/001	ANELLO A "D" 25X20X4 -"D" RING	FERRO	IRON	1	3
F/0288/001	ANELLO A "D" 30X25X4 -"D" RING	FERRO	IRON	1	4
F/0294/001	ANELLO A "D" 36X31X4 -"D" RING	FERRO	IRON	1	4
F/0303/001	ANELLO A "D" 30X28X4,9 -"D" RING	FERRO	IRON	1	4
F/0312/001	ANELLO A "D" 40X30X5 -"D" RING	FERRO	IRON	1	4
F/0314/001	ANELLO A "D" 40X35X5,5 -"D" RING	FERRO	IRON	1	4
F/0317/001	ANELLO A "D" 20X18X6 -"D" RING	FERRO	IRON	1	4
F/0319/001	ANELLO A "D" 25X23X6 -"D" RING	FERRO	IRON	1	4
F/0352/001	ANELLO OVALE 10,5X5X1,5 -OVAL RING	FERRO	IRON	1	5
F/0368/001	ANELLO OVALE 18X6X2,5 -OVAL RING	FERRO	IRON	1	5
F/0370/001	ANELLO OVALE 34X10X2,5 -OVAL RING	FERRO	IRON	1	5
F/0372/001	ANELLO OVALE 16X9X3 -OVAL RING	FERRO	IRON	1	5
F/0378/001	ANELLO OVALE 26X15X3 -OVAL RING	FERRO	IRON	1	6
F/0382/001	ANELLO OVALE 30X6X3 -OVAL RING	FERRO	IRON	1	5
F/0386/001	ANELLO OVALE 40X8X3 -OVAL RING	FERRO	IRON	1	5
F/0388/001	ANELLO OVALE 45X9X3 -OVAL RING	FERRO	IRON	1	5
F/0390/001	ANELLO OVALE 50X9X3 -OVAL RING	FERRO	IRON	1	5
F/0396/001	ANELLO OVALE 20X8X4 -OVAL RING	FERRO	IRON	1	5

ARTICOLO - ITEMS	DESCRIZIONE - DESCRIPTION	MATERIALE	MATERIAL	CAT	PG
F/0397/001	ANELLO OVALE 22X11X4 -OVAL RING	FERRO	IRON	1	6
F/0398/001	ANELLO OVALE 23X8X4 -OVAL RING	FERRO	IRON	1	5
F/0404/001	ANELLO OVALE 25X8X4 -OVAL RING	FERRO	IRON	1	6
F/0406/001	ANELLO OVALE 16X15X4 -OVAL RING	FERRO	IRON	1	6
F/0412/001	ANELLO OVALE 30X8X4 -OVAL RING	FERRO	IRON	1	6
F/0414/001	ANELLO OVALE 33X18X4 -OVAL RING	FERRO	IRON	1	6
F/0418/001	ANELLO OVALE 38X13X4 -OVAL RING	FERRO	IRON	1	7
F/0422/001	ANELLO OVALE 29X24X5 -OVAL RING	FERRO	IRON	1	6
F/0424/001	ANELLO OVALE 33X18X5 -OVAL RING	FERRO	IRON	1	6
F/0428/001	ANELLO OVALE 40X25X5 -OVAL RING	FERRO	IRON	1	7
F/0430/001	ANELLO OVALE 45X18X5 -OVAL RING	FERRO	IRON	1	7
F/0468/001	ANELLO RETTANG. 14X10X2 -RECT.RING	FERRO	IRON	1	8
F/0474/001	ANELLO RETTANG. 17X14X2,4 -RECT.RING	FERRO	IRON	1	8
F/0492/001	ANELLO RETTANG. 25X17X2,8 -RECT.RING	FERRO	IRON	1	8
F/0498/001	ANELLO RETTANG. 20X17X3 -RECT.RING	FERRO	IRON	1	8
F/0502/001	ANELLO RETTANG. 25X14X3 -RECT.RING	FERRO	IRON	1	8
F/0510/001	ANELLO RETTANG. 22X15X4 -RECT.RING	FERRO	IRON	1	7
F/0511/001	ANELLO RETTANG. 25X10X4 -RECT.RING	FERRO	IRON	1	7
F/0512/001	ANELLO RETTANG. 25X20X4 -RECT.RING	FERRO	IRON	1	9
F/0515/001	ANELLO RETTANG. 30X10X4 -RECT.RING	FERRO	IRON	1	9
F/0516/001	ANELLO RETTANG. 33X22X4 -RECT.RING	FERRO	IRON	1	9
F/0518/001	ANELLO RETTANG. 33X18X4 -RECT.RING	FERRO	IRON	1	9
F/0519/001	ANELLO RETTANG. 40X10X4 -RECT.RING	FERRO	IRON	1	9
F/0521/001	ANELLO RETTANG. 40X20X4 -RECT.RING	FERRO	IRON	1	9
F/0522/001	ANELLO RETTANG. 50X10X4 -RECT.RING	FERRO	IRON	1	9
F/0523/001	ANELLO RETTANG. 50X15X4 -RECT.RING	FERRO	IRON	1	9
F/0545/001	ANELLO RETTANG. 25X20X6 -RECT.RING	FERRO	IRON	1	8
F/0548/001	ANELLO RETTANG. 30X20X6 -RECT.RING	FERRO	IRON	1	8
F/0549/001	ANELLO RETTANG. 40X20X6 -RECT.RING	FERRO	IRON	1	8
F/0566/001	ANELLO QUADRATO 25X25X3 -SQUADRED RING	FERRO	IRON	1	10
F/0572/001	ANELLO QUADRATO 15X15X4 -SQUADRED RING	FERRO	IRON	1	10

ARTICOLO - ITEMS	DESCRIZIONE - DESCRIPTION	MATERIALE	MATERIAL	CAT	PG
F/0573/001	ANELLO QUADRATO 20X20X4 -SQUADRED RING	FERRO	IRON	1	10
F/0576/001	ANELLO QUADRATO 25X25X4 -SQUADRED RING	FERRO	IRON	1	10
F/0578/001	ANELLO QUADRATO 30X30X4 -SQUADRED RING	FERRO	IRON	1	10
F/0590/001	ANELLO TRIANG.20X20X20X3 -TRIANG.RING	FERRO	IRON	1	7
F/0600/001	ANELLO TRIANG.25X26X26X4 -TRIANG.RING	FERRO	IRON	1	7
H					
H/0101/006	NASTRO BIADESIVO - DOUBLE SIDED TAPE			21	8
H/0101/009	NASTRO BIADESIVO - DOUBLE SIDED TAPE			21	8
K					
K/0439/000	LUCCHETTO - PADLOCK	OTTONE	SOLID BRASS	6	15
K/0461/000	CHIUSURA TIC TUC - LOCK	FERRO	IRON	6	1
K/0927/006	PORTACHIAVI - KEY CASE FITTING	FERRO	IRON	16	3
K/0958/000	MOLLA A CALAMITA - MAGNETIC LOCK	OTTONE + FERRO	BRASS + IRON	5	2
K/1116/000	CHIUSURA TIC TUC - LOCK	FERRO	IRON	6	1
K/1158/009	GUARNIZIONE CON RIVETTO - STUD WITH RIVET	ZAMA	ZINC ALLOY	10	1
K/1158/012	GUARNIZIONE CON RIVETTO - STUD WITH RIVET	ZAMA	ZINC ALLOY	10	1
K/1159/000	GUARNIZIONE CON RIVETTO - STUD WITH RIVET	ZAMA	ZINC ALLOY	10	2
K/1183/007	CHIUSURA PER BRACCIALETTI - LOCK FOR BRACELET	ZAMA	ZINC ALLOY	6	18
K/1251/000	GUARNIZIONE CON RIVETTO - STUD WITH RIVET	ZAMA	ZINC ALLOY	10	4
K/1263/030	FIBBIA MILITARE - MILITARY BUCKLE	FERRO	IRON	8	36
K/1277/025	GUARNIZIONE CON RIVETTO - STUD WITH RIVET	ZAMA	ZINC ALLOY	10	4
K/1293/040	FIBBIA DOPPIA - BUCKLE	ZAMA	ZINC ALLOY	8	13
K/1352/000	CHIUSURA CON GIRELLO - LOCK	ZAMA	ZINC ALLOY	6	6
K/1353/001	TIRALAMPO CON CURSORE - ZIP PULLER WITH SLIDER	ZAMA	ZINC ALLOY	20	2
K/1378/040	FIBBIA DOPPIA - BUCKLE	ZAMA	ZINC ALLOY	8	11
K/1580/015	CHIUSURA PER BRACCIALETTI - LOCK FOR BRACELET	ZAMA	ZINC ALLOY	6	18
K/1603/016	MOSCHETTONE - DOG CLIP	ZAMA	ZINC ALLOY	12	15
K/1615/010	GUARNIZIONE CON RIVETTO - STUD WITH RIVET	FERRO	IRON	10	3
K/1615/012	GUARNIZIONE CON RIVETTO - STUD WITH RIVET	FERRO	IRON	10	3
K/1626/040	MEZZA FIBBIA - BUCKLE	ZAMA	ZINC ALLOY	8	22
K/1639/035	MEZZA FIBBIA - BUCKLE	ZAMA	ZINC ALLOY	8	22

ARTICOLO - ITEMS	DESCRIZIONE - DESCRIPTION	MATERIALE	MATERIAL	CAT	PG
K/1641/035	MEZZA FIBBIA - BUCKLE	ZAMA	ZINC ALLOY	8	22
K/1642/035	MEZZA FIBBIA - BUCKLE	ZAMA	ZINC ALLOY	8	22
K/1643/005	CHIUSURA PER BRACCIALETTI - LOCK FOR BRACELET	ZAMA	ZINC ALLOY	6	18
K/1657/008	CHIUSURA PER BRACCIALETTI - LOCK FOR BRACELET	ZAMA	ZINC ALLOY	6	17
K/1677/010	CHIUSURA PER BRACCIALETTI - LOCK FOR BRACELET	ZAMA	ZINC ALLOY	6	18
K/1679/010	CHIUSURA PER BRACCIALETTI - LOCK FOR BRACELET	ZAMA	ZINC ALLOY	6	18
K/1681/020	CHIUSURA CON BOTTONE AUTOMATICO - LOCK	ZAMA	ZINC ALLOY	6	14
K/1681/028	CHIUSURA CON BOTTONE AUTOMATICO - LOCK	ZAMA	ZINC ALLOY	6	14
K/1681/036	CHIUSURA CON BOTTONE AUTOMATICO - LOCK	ZAMA	ZINC ALLOY	6	14
K/2046/020	CERNIERA A MOLLA CON FORI - PAK PAK FRAME	ACCIAIO	STEEL	7	1
K/2466/001	ATTACCO - HANDLE HOLDER	FERRO	IRON	7	1
K/2466/002	DADO - DICE	FERRO	IRON	7	1
K/7708/027	CERNIERA OLD WEST - OLD WEST FRAME	FERRO	IRON	7	1
K/7708/030	CERNIERA OLD WEST - OLD WEST FRAME	FERRO	IRON	7	1
K/7708/035	CERNIERA OLD WEST - OLD WEST FRAME	FERRO	IRON	7	1
K/7708/040	CERNIERA OLD WEST - OLD WEST FRAME	FERRO	IRON	7	1
K/7708/045	CERNIERA OLD WEST - OLD WEST FRAME	FERRO	IRON	7	1
K/7708/050	CERNIERA OLD WEST - OLD WEST FRAME	FERRO	IRON	7	1
M					
M/0457/001	RIVETTO - RIVET	FERRO	IRON	17	2
M/0469/001	RIVETTO - RIVET	FERRO	IRON	17	2
M/0685/001	GEMELLO FILETTATO 3MA - 3MA THREADED STUD	OTTONE	SOLID BRASS	9	1
M/0720/005	VITE 3MA X 5 - SCREW	FERRO	IRON	9	2
M/0720/007	VITE 3MA X 7 - SCREW	FERRO	IRON	9	2
M/0720/010	VITE 3MA X 10 - SCREW	FERRO	IRON	9	2
M/0720/012	VITE 3MA X 12 - SCREW	FERRO	IRON	9	2
M/0970/006	BASE PER CHIUSURA CON CALAMITA - BASE FOR MAGNETIC LOCK	FERRO	IRON	9	2
U					
U/0143/000	FORO' - KAND KNIFE	OTTONE + FERRO	BRASS + IRON	21	3
U/0144/000	FORO' - KAND KNIFE	FERRO + PLASTICA	IRON + PLASTIC	21	3
U/0151/060	PUNTERUOLO - PIN HOLE KNIFE	FERRO + LEGNO	IRON + WOOD	21	5

ARTICOLO - ITEMS	DESCRIZIONE - DESCRIPTION	MATERIALE	MATERIAL	CAT	PG
U/0198/000	STECCA PER RIMBOCCARE - BONE FOR FOLDING	OSSO	BONE	21	5
U/0204/007	FORBICI - SCISSOR	FERRO	IRON	21	2
U/0204/008	FORBICI - SCISSOR	FERRO	IRON	21	2
U/0204/009	FORBICI - SCISSOR	FERRO	IRON	21	2
U/0240/150	COMPASSO - COMPASS	FERRO	IRON	21	5
U/0246/000	PINZA A FUSTELLA - HOLE PUNCH	FERRO	IRON	21	4
U/0247/000	PINZA A FUSTELLA - HOLE PUNCH	FERRO	IRON	21	4
U/0251/....	FUSTELLA TONDA - POUND HAND PUNCH	FERRO	IRON	21	1
U/0282/000	MARTELLO PER PELLETTERIA - HAMMER	FERRO + LEGNO	IRON + WOOD	21	1
U/0294/000	FORBICI - SCISSOR	FERRO	IRON	21	2
U/0350/000	TRINCETTO - CUTTER	FERRO + PLASTICA	IRON + PLASTIC	21	3
U/0374/000	INFILA CURSORI - ZIP MACHINE	FERRO	IRON	21	6
U/0442/000	SPESSIMETRO - LEATHER GAUGE	FERRO	IRON	21	5
U/0651/....	FUSTELLA OVALE - OVAL HAND PUNCH	FERRO	IRON	21	1
U/0741/000	FORBICI - SCISSOR	FERRO	IRON	21	2
U/0749/002	TORCHIETTO - HANDLE MACHINE	FERRO	IRON	21	6
X					
X/0172/044/...	SALPA - REGENERATED LEHATER	REGENERATO DI CUOIO	LEATH CONGLOMERATE	21	7
X/0172/045/...	SALPA - REGENERATED LEHATER	REGENERATO DI CUOIO	LEATH CONGLOMERATE	21	7
X/0771/121/...	CERNIERA LAMPO MM 6 - MM 6 ZIPPER	NYLON	NYLON	20	7
X/0858/040	BORDINO PLASTICA FORATO - ROD/HOSE	PLASTICA	PLASTIC	21	8
X/0942/042	CORDONE - CORD	COTONE	COTTON	21	8
X/0964/046/...	SUGHERITR - REGENERATED CORK	SUGHERO	CORK	21	7
X/1/60/0012	CATENA - CHAIN	ALLUMINIO ANODIZZATO	ANOD ALLUM	4	2
X/1/60/0018	CATENA - CHAIN	ALLUMINIO ANODIZZATO	ANOD ALLUM	4	2
X/1/60/0019	CATENA - CHAIN	ALLUMINIO ANODIZZATO	ANOD ALLUM	4	2
X/1/60/0026	CATENA - CHAIN	ALLUMINIO ANODIZZATO	ANOD ALLUM	4	1
X/1/60/0027	CATENA - CHAIN	ALLUMINIO ANODIZZATO	ANOD ALLUM	4	1
X/1/60/0033	CATENA - CHAIN	ALLUMINIO ANODIZZATO	ANOD ALLUM	4	1
X/1/60/0034	CATENA - CHAIN	ALLUMINIO ANODIZZATO	ANOD ALLUM	4	1
X/1/60/0040	CATENA - CHAIN	ALLUMINIO ANODIZZATO	ANOD ALLUM	4	1

ARTICOLO - ITEMS	DESCRIZIONE - DESCRIPTION	MATERIALE	MATERIAL	CAT	PG
X/1/60/0065	CATENA - CHAIN	ALLUMINIO ANODIZZATO	ANOD ALLUM	4	1
X/14/14/...	502 GRAPPETTA - CLAMP	FERRO	IRON	19	1
OCCHIELLI EYELET					
D/060/2P	OCCHIELLO - EYELET	OTTONE	IRON	13	3
D/0602/2	OCCHIELLO - EYELET	OTTONE	IRON	13	3
D/070/2P	OCCHIELLO - EYELET	OTTONE	IRON	13	3
D/0702/2	OCCHIELLO - EYELET	OTTONE	IRON	13	3
D/080/2P	OCCHIELLO - EYELET	OTTONE	IRON	13	3
D/0802/2	OCCHIELLO - EYELET	OTTONE	IRON	13	3
D/090/2P	OCCHIELLO - EYELET	OTTONE	IRON	13	3
D/0902/2	OCCHIELLO - EYELET	OTTONE	IRON	13	3
D/100/2P	OCCHIELLO - EYELET	OTTONE	IRON	13	3
D/102/2	OCCHIELLO - EYELET	OTTONE	IRON	13	3
D/152/2	OCCHIELLO - EYELET	OTTONE	IRON	13	3
D/170/2P	OCCHIELLO - EYELET	OTTONE	IRON	13	3
D/172/2	OCCHIELLO - EYELET	OTTONE	IRON	13	3
VL 21	OCCHIELLO - EYELET	OTTONE	SOLID BRASS	13	1
VL 31	OCCHIELLO - EYELET	OTTONE	SOLID BRASS	13	1
VL 31 P	OCCHIELLO - EYELET	OTTONE	SOLID BRASS	13	2
VL 40	OCCHIELLO - EYELET	OTTONE	SOLID BRASS	13	1
VL 40 P	OCCHIELLO - EYELET	OTTONE	SOLID BRASS	13	2
VL 50	OCCHIELLO - EYELET	OTTONE	SOLID BRASS	13	1
VL 50 P	OCCHIELLO - EYELET	OTTONE	SOLID BRASS	13	2
VL 60	OCCHIELLO - EYELET	OTTONE	SOLID BRASS	13	1
VL 60 P	OCCHIELLO - EYELET	OTTONE	SOLID BRASS	13	2
VL 60 TB	OCCHIELLO - EYELET	FERRO O OTTONE	IRON OR BRASS	13	2
VL 70	OCCHIELLO - EYELET	OTTONE	SOLID BRASS	13	1
VL 70 P	OCCHIELLO - EYELET	OTTONE	SOLID BRASS	13	2
VL 70 TB	OCCHIELLO - EYELET	OTTONE	SOLID BRASS	13	2
VL 80	OCCHIELLO - EYELET	OTTONE	SOLID BRASS	13	1
VL 80 P	OCCHIELLO - EYELET	OTTONE	SOLID BRASS	13	2

ARTICOLO - ITEMS	DESCRIZIONE - DESCRIPTION	MATERIALE	MATERIAL	CAT	PG
VL 80 TB	OCCHIELLO - EYELET	FERRO	IRON	13	2
RIVETTI - RIVETS					
4007	RIVETTO - RIVET	FERRO	IRON	17	1
00	RIVETTO - RIVET	FERRO	IRON	17	1
00 D	RIVETTO - RIVET	FERRO	IRON	17	1
00 TS	RIVETTO - RIVET	FERRO	IRON	17	2
000	RIVETTO - RIVET	FERRO	IRON	17	1
026	RIVETTO - RIVET	FERRO	IRON	17	1
026 D	RIVETTO - RIVET	FERRO	IRON	17	1
033	RIVETTO - RIVET	FERRO	IRON	17	1
033 3/4	RIVETTO - RIVET	FERRO	IRON	17	1
033 3/4 D	RIVETTO - RIVET	FERRO	IRON	17	1
033 8/9	RIVETTO - RIVET	FERRO	IRON	17	1
033 8/9 D	RIVETTO - RIVET	FERRO	IRON	17	1
033 D	RIVETTO - RIVET	FERRO	IRON	17	1
033 T	RIVETTO - RIVET	OTTONE	SOLID BRASS	17	2
033 TC	RIVETTO - RIVET	OTTONE	SOLID BRASS	17	2
033 TP	RIVETTO - RIVET	OTTONE	SOLID BRASS	17	2
033 TS	RIVETTO - RIVET	FERRO	IRON	17	2
034 D	RIVETTO - RIVET	FERRO	IRON	17	1
034 TS	RIVETTO - RIVET	FERRO	IRON	17	2
036	RIVETTO - RIVET	FERRO	IRON	17	1
036 D	RIVETTO - RIVET	FERRO	IRON	17	1
036 T	RIVETTO - RIVET	FERRO	IRON	17	2
036 TC	RIVETTO - RIVET	FERRO	IRON	17	2
036 TS	RIVETTO - RIVET	FERRO	IRON	17	2
037 TC	RIVETTO - RIVET	FERRO	IRON	17	2
037 TS	RIVETTO - RIVET	FERRO	IRON	17	2
042	RIVETTO - RIVET	FERRO	IRON	17	1
042 D	RIVETTO - RIVET	FERRO	IRON	17	1

GERMANY

NAME: MODITAL ZUBEHÖR GMBH
 TOWN: OBERTSHAUSEN
 PHONE: 06104 802661
 FAX: 06104 802497
 E-mail: modital@web.de

HOLLAND - BELGIUM

NAME: W.W. WAALWIJK B.V.
 TOWN: PT WAALWIJK
 PHONE: 0416 333651
 FAX: 0416 334216
 E-mail: ad.timmers@wildeman-waalwijk.nl

FRANCE

NAME: F.G.M. SARL
 TOWN: GRAULHET - CEDEX
 PHONE: 05 63347256
 FAX: 05 63341809
 E-mail: f.g.m@wanadoo.fr

POLAND

NAME: AFB MICHAL TARCZYNSKI
 TOWN: PRZEMYSL
 PHONE: 016 6791662
 FAX: 016 6791662
 E-mail: afb@post.pl

PORTUGAL

NAME: CAMBON L. DA.
 TOWN: LISBOA
 PHONE: 021 351 4090
 FAX: 021 351 4099
 E-mail: cambon.lida@gmail.com

UNITED KINGDOM

NAME: ALDEN FITTINGS LTD
 TOWN: LONDON
 PHONE: 0208 531 3358
 FAX: 0208 5279105
 E-mail: aldenfittings@gmail.com.fsbusiness.co.uk

USA

NAME: MILFORD ENTERPRISES INC
 TOWN: DIX HILLS (NEW YORK)
 PHONE: 001 631 2201005
 FAX: 001 631 8249354
 E-mail: michelle@milfordleathers.com

CANADA

NAME: VERESHACK AGENCIES LTD
 TOWN: TORONTO
 PHONE: 416 4819160
 FAX: 416 4817017
 E-mail: j.vereshack@sympatico.ca

VENEZUELA

NAME: SAINT MORITZ srl
 TOWN: CHACAO - CARACAS
 PHONE: 0212 2665541
 FAX: 0212 2665541
 E-mail: trestifo@hotmail.com

COLOMBIA

NAME: ABC HERRAJES LTDA
 TOWN: SANTAFE' DE BOGOTA'
 PHONE: 1 2354949
 FAX: 1 2354962
 E-mail: gerenciagerardo@abcherrajes.com

Il nostro ufficio export è a vostra disposizione per qualsiasi necessità all'indirizzo export@abcmorini.it

In case of assistance, please do not hesitate to contact our export department at the following address:
export@abcmorini.it

A.B.C. MORINI srl

Via Ilio Barontini, 1 5/b - San Colombano -
 50018 Scandicci FIRENZE
T. (+39) 055 722571
F. (+39) 055 7224232
E. abcmorini@abcmorini.it
W. www.abcmorini.it